





OPERATING INSTRUCTIONS

R-965
Audio/Video Receiver

Introduction

READ THIS BEFORE OPERATING YOUR UNIT

 <div style="border: 1px solid black; padding: 2px; display: inline-block; text-align: center;"> CAUTION <small>RISK OF ELECTRIC SHOCK DO NOT OPEN</small> </div> 	<p>This symbol is intended to alert the user to the presence of uninsulated "dangerous voltage" within the product's enclosure that may be of sufficient magnitude to constitute a risk of electric shock to persons.</p>
<p>CAUTION : TO REDUCE THE RISK OF ELECTRIC SHOCK, DO NOT REMOVE COVER (OR BACK). NO USER-SERVICEABLE PARTS INSIDE. REFER SERVICING TO QUALIFIED SERVICE PERSONNEL.</p>	<p>This symbol is intended to alert the user to the presence of important operating and maintenance (servicing) instructions in the literature accompanying the appliance.</p>

WARNING : TO REDUCE THE RISK OF FIRE OR ELECTRIC SHOCK, DO NOT EXPOSE THIS APPLIANCE TO RAIN OR MOISTURE.

Note to CATV System Installer :
 This reminder is provided to call the CATV system installer's attention to Article 820-40 of the NEC that provides guidelines for proper grounding and, in particular, specifies that the cable ground shall be connected to the grounding system of the building, as close to the point of cable entry as practical.

FCC INFORMATION
 This equipment has been tested and found to comply with the limits for a Class B digital device, pursuant to Part 15 of the FCC Rules. These limits are designed to provide reasonable protection against harmful interference in a residential installation. This equipment generates, uses and can radiate radio frequency energy and, if not installed and used in accordance with the instructions, may cause harmful interference to radio communications. However, there is no guarantee that interference will not occur in a particular installation. If this equipment does cause harmful interference to radio or television reception, which can be determined by turning the equipment off and on, the user is encouraged to try to correct the interference by one or more of the following measures:

- Reorient or relocate the receiving antenna.
- Increase the separation between the equipment and receiver.
- Connect the equipment into an outlet on a circuit different from that to which the receiver is connected.
- Consult the dealer or an experienced radio/TV technician for help.

Caution : Any changes or modifications in construction of this device which are not expressly approved by the party responsible for compliance could void the user's authority to operate the equipment.

FOR YOUR SAFETY		
U.S.A CANADA	120 V	<p>Units shipped to the U.S.A and Canada are designed for operation on 120 V AC only.</p> <p>Safety precaution with use of a polarized AC plug. However, some products may be supplied with a nonpolarized plug.</p> <p>CAUTION : To prevent electric shock, match wide blade of plug to wide slot, fully insert.</p> <p>ATTENTION : Pour éviter chocs électriques, introduire la lame la plus large de la fiche dans la borne correspondante de la prise et pousser jusqu' au fond.</p>
<ul style="list-style-type: none"> • Avoid high temperatures. Allow for sufficient heat dispersion when installed on a rack. • Keep the set free from moisture, water, and dust. • Do not let foreign objects in the set. • Handle the power cord carefully. Hold the plug when unplugging the cord. • Unplug the power cord when not using the set for long periods of time. • Do not obstruct the ventilation holes. • Do not let insecticides, benzene, and thinner come in contact with the set. • Never disassemble or modify the set in any way. 		

SAFETY INSTRUCTION

- Read Instructions** - All the safety and operating instructions should be read before the product is operated.
- Retain instructions** - The safety and operating instructions should be retained for future reference.
- Heed Warnings** - All warnings on the product and in the operating instructions should be adhered to.
- Follow Instructions** - All operating and use instructions should be followed.
- Cleaning** - Unplug this product from the wall outlet before cleaning. Do not use liquid cleaners or aerosol cleaners. Use a damp cloth for cleaning.
- Attachments** - Do not use attachments not recommended by the product manufacturer as they may cause hazards.
- Water and Moisture** - Do not use this product near water - for example, near a bath tub, wash bowl, kitchen sink, or laundry tub; in a wet basement, or near a swimming pool; and the like.
- Accessories** - Do not place this product on an unstable cart, stand, tripod, bracket, or table. The product may fall, causing serious injury to a child or adult, and serious damage to the product. Use only with a cart, stand, tripod, bracket, or table recommended by the manufacturer, or sold with the product. Any mounting of the product should follow the manufacturer's instructions, and should use a mounting accessory recommended by the manufacturer.
- A product and cart combination should be moved with care. Quick stops, excessive force, and uneven surfaces may cause the product and cart combination to overturn.
- Ventilation** - Slots and openings in the cabinet are provided for ventilation and to ensure reliable operation of the product and to protect it from overheating, and these openings must not be blocked or covered. The openings should never be blocked by placing the product on a bed, sofa, rug, or other similar surface. This product should not be placed in a built-in installation such as a bookcase or rack unless proper ventilation is provided or the manufacturer's instructions have been adhered to.
- Power Sources** - This product should be operated only from the type of power source indicated on the marking label. If you are not sure of the type of power supply to your home, consult your product dealer or local power company. For products intended to operate from battery power, or other sources, refer to the operating instructions.
- Grounding or Polarization** - This product may be equipped with a polarized alternating-current line plug (a plug having one blade wider than the other). This plug will fit into the power outlet only one way. This is a safety feature. If you are unable to insert the plug fully into the outlet, try reversing the plug. If the plug should still fail to fit, contact your electrician to replace your obsolete outlet. Do not defeat the safety purpose of the polarized plug.
Alternate Warnings - This product is equipped with a three-wire grounding-type plug, a plug having a third(grounding) pin. This plug will only fit into a grounding-type power outlet. this is a safety feature. If you are unable to insert the plug into the outlet, contact your electrician to replace your obsolete outlet. Do not defeat the safety purpose of the grounding-type plug.
- Power-Cord Protection** - Power-supply cords should be routed so that they are not likely to be walked on or pinched by items placed upon or against them, paying particular attention to cords at plugs, convenience receptacles, and the point where they exit from the product.
- Outdoor Antenna Grounding** - If an outside antenna or cable system is connected to the product, be sure the antenna or cable system is grounded so as to provide some protection against voltage surges and built-up static charges. Article 810 of the National Electrical Code, ANSI/NFPA 70, provides information with regard to proper grounding of the mast and supporting structure, grounding of the lead-in wire to an antenna discharge unit, size of



PORTABLE CART WARNING

grounding conductors, location of antenna-discharge unit, connection to grounding electrodes, and requirements for the grounding electrode. See Figure 1.

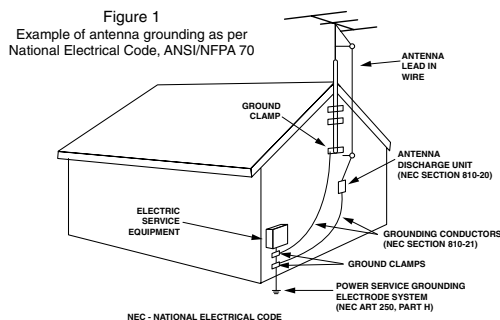

- Lightning** - For added protection for this product during a lightning storm, or when it is left unattended and unused for long periods of time, unplug it from the wall outlet and disconnect the antenna or cable system. This will prevent damage to the product due to lightning and power-line surges.
- Power Lines** - An outside antenna system should not be located in the vicinity of overhead power lines or other electric light or power circuits, or where it can fall into such power lines or circuits. When installing an outside antenna system, extreme care should be taken to keep from touching such power lines or circuits as contact with them might be fatal.
- Overloading** - Do not overload wall outlets, extension cords, or integral convenience receptacles as this can result in a risk of fire or electric shock.
- Object and Liquid Entry** - Never push objects of any kind into this product through openings as they may touch dangerous voltage points or short-out parts that could result in a fire or electric shock. Never spill liquid of any kind on the product.
- Servicing** - Do not attempt to service this product yourself as opening or removing covers may expose you to dangerous voltage or other hazards. Refer all servicing to qualified service personnel.
- Damage Requiring Service** - Unplug this product from the wall outlet and refer servicing to qualified service personnel under the following conditions:
 - When the power-supply cord or plug is damaged,
 - If liquid has been spilled, or objects have fallen into the product,
 - If the product has been exposed to rain or water,
 - If the product does not operate normally by following the operating instructions. Adjust only those controls that are covered by the operating instructions as an improper adjustment of other controls may result in damage and will often require extensive work by a qualified technician to restore the product to its normal operation.
 - If the product has been dropped or damaged in any way, and
 - When the product exhibits a distinct change in performance - this indicates a need for service.
- Replacement Parts** - When replacement parts are required, be sure the service technician has used replacement parts specified by the manufacturer or have the same characteristics as the original part. Unauthorized substitutions may result in fire, electric shock, or other hazards.
- Safety Check** - Upon completion of any service or repairs to this product, ask the service technician to perform safety checks to determine that the product is in proper operating condition.
- Wall or Ceiling Mounting** - The product should be mounted to a wall or ceiling only as recommended by the manufacturer.
- Heat** - The product should be situated away from heat sources such as radiators, heat registers, stoves, or other products (including amplifiers) that produce heat.

CONTENTS

- **Introduction**
 - READ THIS BEFORE OPERATING YOUR UNIT | 2
 - SAFETY INSTRUCTION | 3
- **System Connections** | 5
- **Front Panel Controls** | 15
- **Universal Remote Controls** | 17
 - OPERATING COMPONENTS WITH REMOTE CONTROL | 20
 - REMOTE CONTROL OPERATION RANGE | 20
 - LOADING BATTERIES | 20
 - ENTERING A SETUP CODE | 21
- **ROOM 2 Remote Controls**
 - REMOTE CONTROL OPERATION RANGE | 23
 - LOADING BATTERIES | 23
- **Operations**
 - LISTENING TO A PROGRAM SOURCE | 24
 - SURROUND SOUND | 27
 - ENJOYING SURROUND SOUND | 30
 - LISTENING TO RADIO BROADCASTS | 35
 - RECORDING | 38
 - DIGITAL AUDIO RECORDING WITH MD RECORDER | 39
 - OTHER FUNCTIONS | 40
 - ROOM 2 SOURCE PLAYBACK | 42
- **Using the OSD**
 - CURRENT STATUS DISPLAY | 43
- **OSD Menu Settings** | 43
 - SETTING THE POWER AMP ASSIGN | 45
 - SETTING THE SPEAKER SETUP | 45
 - SETTING THE SYSTEM SETUP | 53
 - SETTING THE SURROUND SETUP | 60
 - SETTING THE CH LEVEL SETUP | 63
 - SETTING THE ROOM2 FEED SETUP | 66
- **Troubleshooting Guide** | 68
- **Specifications** | 69

System Connections

- Please be certain that this unit is unplugged from the AC outlet before making any connections.
- Since different components often have different terminal names, carefully read the operating instructions of the component connected.
- Be sure to observe the color coding when connecting audio, video and speaker cords.
- Make connections firmly and correctly. If not, it can cause loss of sound, noise or damage to the unit.

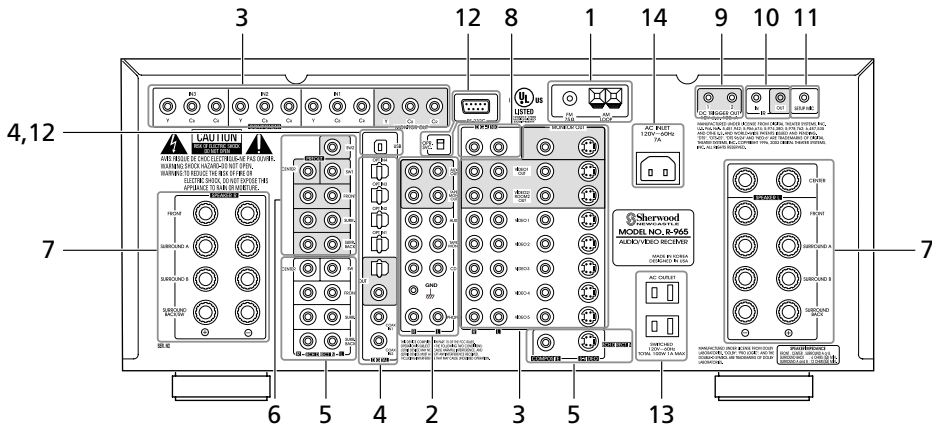

1. CONNECTING ANTENNAS

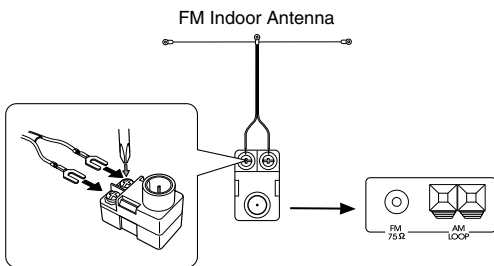

- Change the position of the FM indoor antenna until you get the best reception of your favorite FM stations.

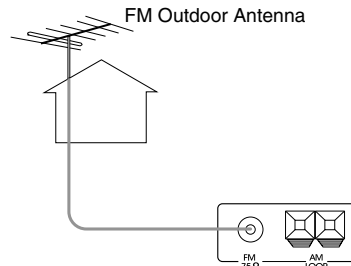

- A 75Ω outdoor FM antenna may be used to further improve the reception. Disconnect the indoor antenna before replacing it with the outdoor one.

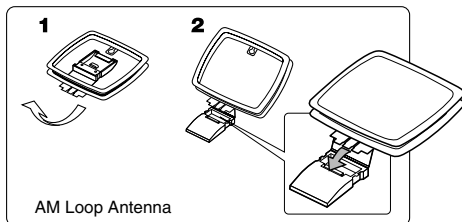

- Place the AM loop antenna as far as possible from the receiver, TV set, speaker cords and the AC input cord and set it to a direction for the best reception.
- If the reception is poor with the AM loop antenna, an AM outdoor antenna can be used in place of the AM loop antenna.

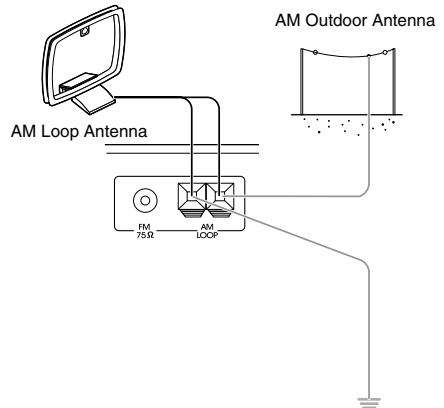

2. CONNECTING AUDIO COMPONENTS

■ Note:

- Do not connect the turntable with MC type cartridge directly. If you have it, use a separate head amplifier or set-up transformer.

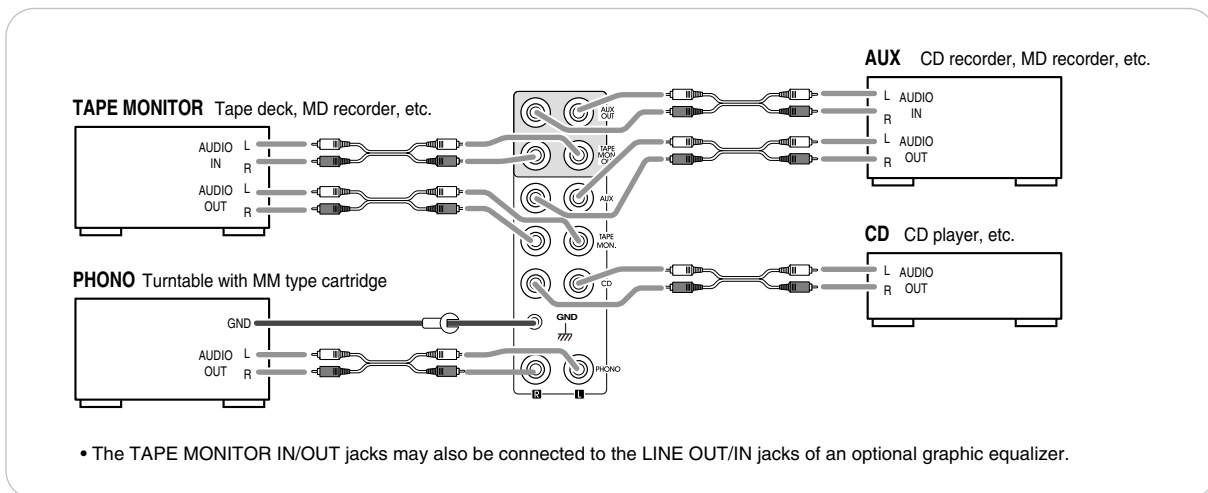

3. CONNECTING VIDEO COMPONENTS

- There are three types of video jacks (COMPONENT, S-VIDEO, COMPOSITE) for connecting video components. Connect them to the corresponding video jacks according to their capability.
- For your reference, the excellence in picture quality is as follows : “COMPONENT” > “S-VIDEO” > “COMPOSITE” .
- When making COMPONENT VIDEO connections, connect “Y” to “Y”, “Cb” to “Cb”(or “B-Y”, “Pb”) and “Cr” to “Cr”(or “R-Y”, “Pr”).
- When connecting to video recording component such as video deck, DVD recorder, etc . or TV for ROOM 2, you must use the same type of video jacks that you did connect to video playback components such as DVD player, LD player, etc.
- This unit is equipped with a function that up-converts composite video or S-Video signals to component video signals or down-converts S-Video signals to composite video signals and outputs them from the MONITOR OUTs. Because of this, one of three types of MONITOR OUT jacks can be connected to the monitor TV regardless of how the video components are connected to VIDEO IN jacks of this unit.
- Connect the video components, referring to the following table.

■ Relationship between the video input signal and video output signal

Video input signals			MONITOR OUTs			VIDEO 2 / ROOM 2 OUTs	
COMPONENT	S-VIDEO	COMPOSITE	COMPONENT	S-VIDEO	COMPOSITE	S-VIDEO	COMPOSITE
×	×	○	Composite	Composite	Composite	×	Composite
×	○	×	S-Video	S-Video	S-Video	S-Video	×
×	○	○	S-Video	S-Video	Composite	S-Video	Composite
○	×	×	Component	×	×	×	×
○	×	○	Component	Composite	Composite	×	Composite
○	○	×	Component	S-Video	S-Video	S-Video	×
○	○	○	Component	S-Video	Composite	S-Video	Composite

■ Notes :

- In such a case of making only COMPONENT VIDEO connections between this receiver and video component, while viewing a movie via MONITOR COMPONENT OUTs, if the OSD menu operation is performed with the OSD, CURSOR control(▲, ▼, ◀, ▶), ENTER buttons, etc., the picture is automatically turned off and only the OSD menu is displayed.
- When S-Video signals and composite video signals are input into this receiver, even though the OSD menu operation is performed, the OSD menu cannot be displayed via MONITOR COMPOSITE OUT.
- When sherwood DVD player such as V-768, etc. is connected to the DIGI-LINK jack for system control, you should connect the DVD player to the “ VIDEO 2” jacks of this unit. Because, if the PLAY button, etc. is pressed on the DVD player, the VIDEO 2 is automatically selected as an input source on this unit. Then playback, etc. starts.

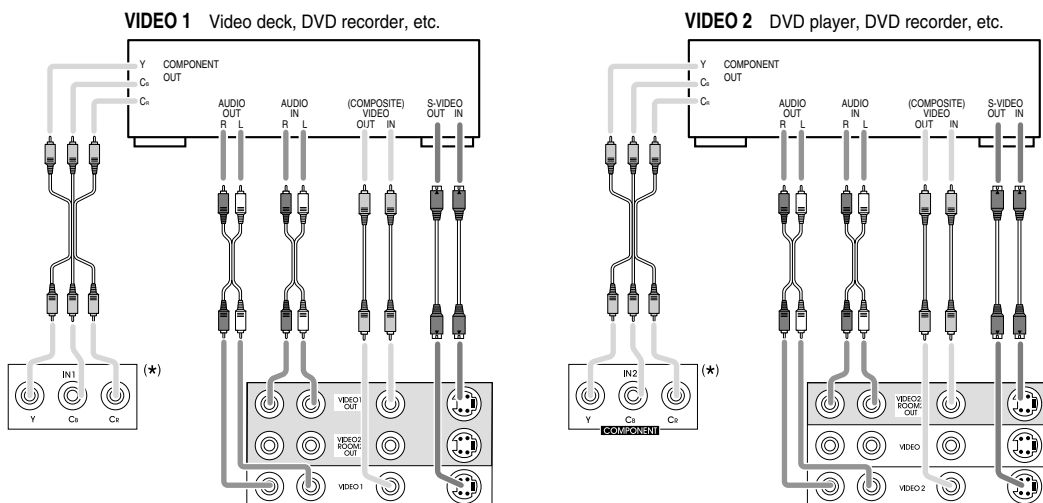

- The jacks of VIDEO 1 / VIDEO 2 may also be connected to a DVD recorder or other digital video recording component. For details , refer to the operating instructions of the component to be connected.
- For ROOM 2 playback, the VIDEO 2 / ROOM 2 OUT jacks can be connected to the amplifier, TV , etc. installed in another room. (For details , refer to “ROOM 2 connections” on page 12.)

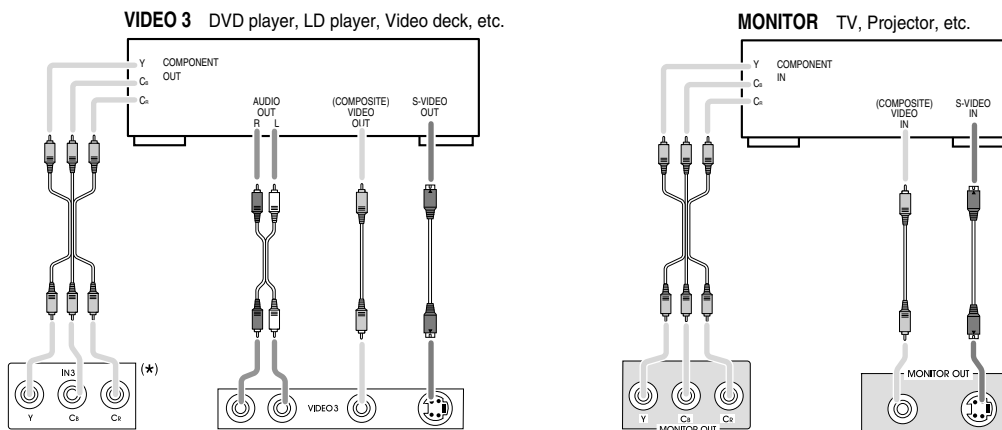

- The jacks of VIDEO 3 / VIDEO 4 / VIDEO 5 can also be connected to an additional video component such as a cable TV tuner, an LD player or satellite system .
- Connect the jacks of VIDEO 4 / VIDEO 5 to the video components in the same way.

■ **Component video input default settings : (*)**

- If you connect the COMPONENT VIDEO INs to your video components, it is easier to do so following the default settings.
- If your component video connections are different from the default setting , you should assign the COMPONENT VIDEO INs you used with the “When selecting the COMPONENT VIDEO SETUP” procedure on page 56.
- The default settings are as follows :
COMPONENT IN 1 : VIDEO 1, COMPONENT IN 2 : VIDEO 2, COMPONENT IN 3 : VIDEO 3

4. CONNECTING DIGITAL INs and OUTs

- The OPTICAL and the COAXIAL DIGITAL OUTs of the components that are connected to CD, AUX and VIDEO 1~ VIDEO 6 of this unit can be connected to these DIGITAL INs.
- A digital input should be connected to the components such as a CD player, LD player, DVD player, etc. capable of outputting DTS Digital Surround, Dolby Digital or PCM format digital signals, etc.
- If the component with OPTICAL or COAXIAL IN jack is connected to the OPTICAL or COAXIAL OUT jack of this unit, you can record the high quality sound of CDs , etc. without degradation.
- For ROOM 2 playback, the COAXIAL DIGITAL OUT can be connected to the amplifier, etc. installed in another room.(For details, refer to “ROOM 2 connections” on page 12.)
- For details, refer to the operating instructions of the component connected.
- When making the COAXIAL DIGITAL connection, be sure to use a 75 Ω COAXIAL cord, not a conventional AUDIO cord.
- All of the commercially available optical fiber cords cannot be used for the equipment. If there is an optical fiber cord which cannot be connected to your equipment, consult your dealer or nearest service organization.

■Note :

- Be sure to make either a OPTICAL or a COAXIAL DIGITAL connection on each component. (You don't need to do both.)

■USB audio connection

- The USB audio connection feature allows you connect a PC to this receiver to hear soundtracks from your PC. USB device controls on the computer (such as volume) may or may not work. In either case, we recommend leaving all volume controls on the computer max and controlling volume from this receiver.
- You may update the operating software through this USB connection in the future.(For details, refer to “CONNECTING PC FOR UPGRADES” on page 14.)

■Notes:

- This USB terminal only supports 2 channel PCM signals. In case of other digital signals, loud noise or no sound may be heard from the speakers, and it may be harmful to your ears and damages the speakers.
- The digital signals being input into this USB terminal will not be output from the COAXIAL OUT jack.
- Some operating systems(OSs) may or may not work with this USB terminal.
- The sound may be interrupted, degraded or played back incorrectly due to your PC settings and PC specifications. Refer to the operating instructions of your PC concerning USB devices, etc.
- Don't use other applications on your PC when playing back through this USB connection.
- Sherwood cannot be held responsible for damage to your computer system, software crashes or failures or any other possible computer problems due to this configuration.
- Do not disconnect the USB cable while playing a soundtrack or updating the operating software, etc. Should this happen, it may be result in malfunction or cause damage to the unit.

■Digital input default settings

- If you connect the DIGITAL INs to your components, it is easier to do so following the default settings.
- If your DIGITAL connections are different from default settings, you should assign the DIGITAL INs you used with the “When selecting the DIGITAL INPUT SETUP” procedure on page 53.
- The default settings are as follows :
OPTICAL IN 1 : VIDEO 1, OPTICAL IN 2 : VIDEO 2, OPTICAL IN 3 : VIDEO 3, OPTICAL IN 4 : VIDEO 5, COAXIAL IN 1 : CD, COAXIAL IN 2 : VIDEO 4, (Front) OPTICAL IN 5 : VIDEO 6, USB : AUX.

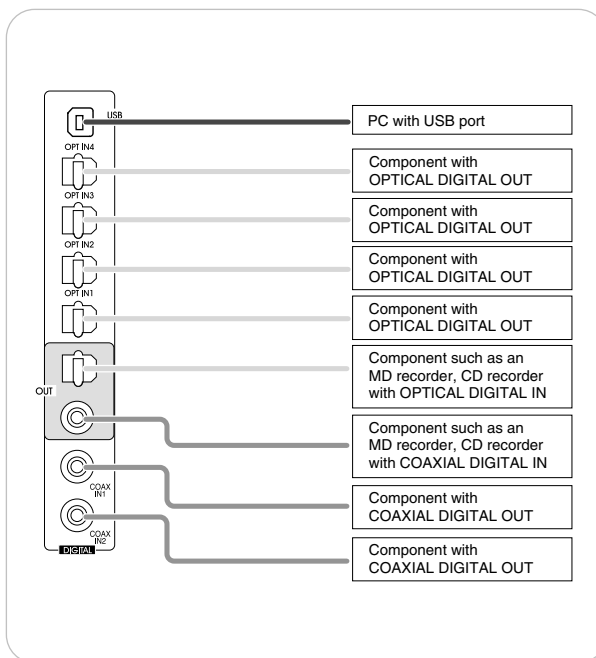

5. CONNECTING 8CH DIRECT INs

- Use these jacks to connect the corresponding analog audio and video outputs of a DVD player or an external decoder, etc. that has 6, 7 or 8 channel outputs.
- In case of 6 or 7 channel outputs, do not connect both of the SURROUND BACK L and R inputs or the SURROUND BACK R input of this unit . (For details, refer to the operating instructions of the component to be connected.)

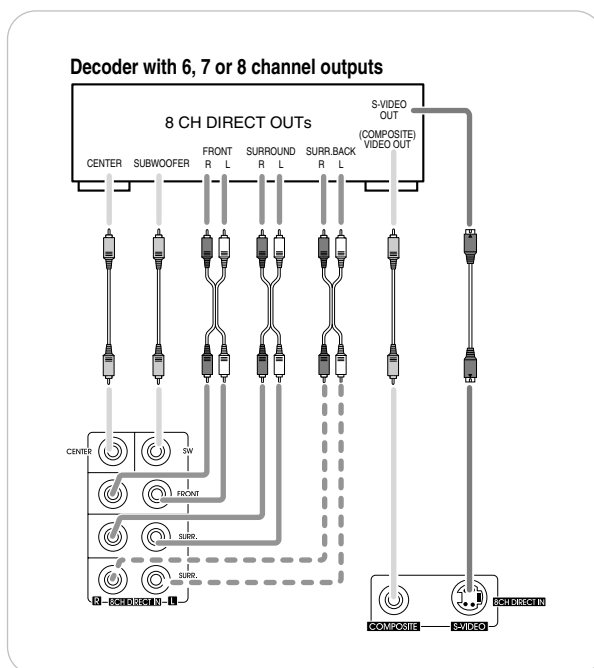

6. CONNECTING PREOUTs

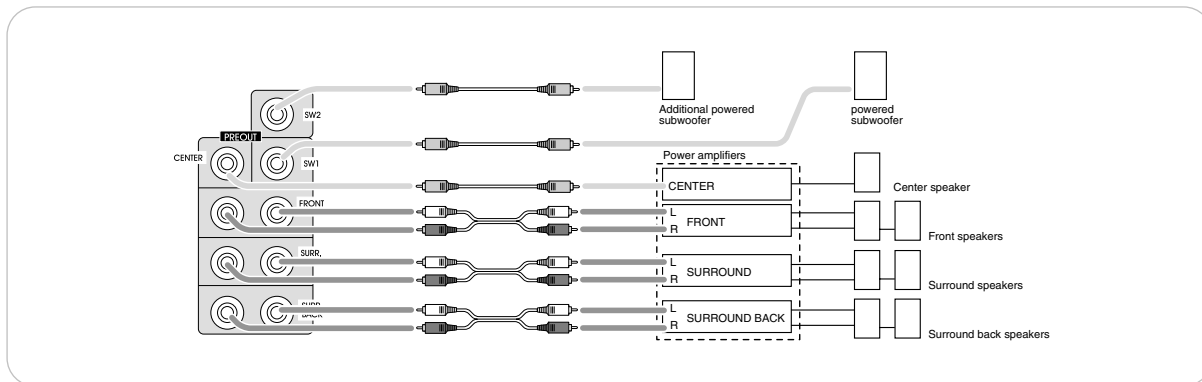

- Use these jacks when adding additional power amplifiers.
- Connect the PREOUT jacks to the powered speakers or the power amplifiers connected to speakers respectively.
- When using only one surround back speaker, connect the SURROUND BACK LEFT jack to the power amplifier.
- If this is the case, you can connect the subwoofer without built-in amplifier to SURROUND BACK RIGHT terminals of the power amplifier.(For details, refer to “When selecting the SUBWOOFER” on page 49.)
- To emphasize the deep bass sounds, connect a powered subwoofer.
- To enjoy deeper bass sounds, connect an additional powered subwoofer to the SUBWOOFER 2 jack.

■Notes :

- After installing the speakers , first adjust the speaker settings according to your environment and speaker layout (For details, refer to “SETTING THE SPEAKER SETUP” on page 45.)
- According to speaker settings, you cannot use either SURROUND BACK RIGHT jack or both of SURROUND BACK jacks.

7. CONNECTING SPEAKERS

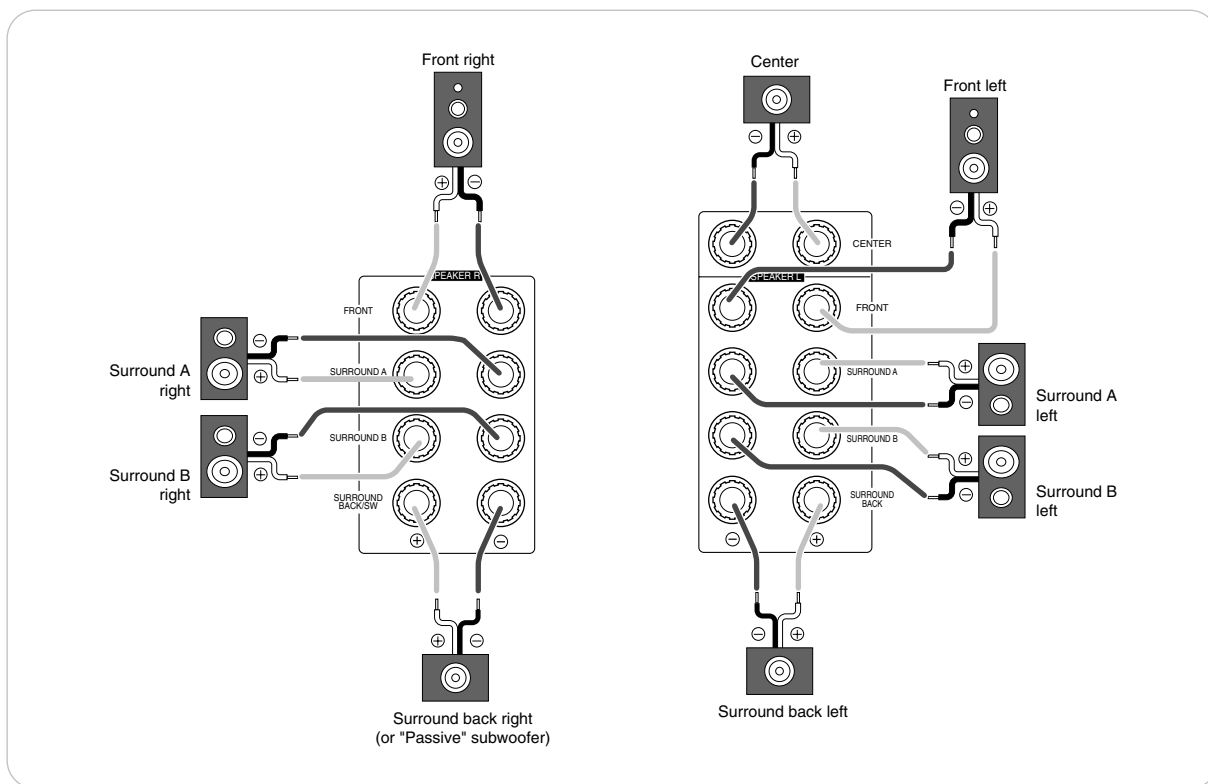

- Be sure to connect speakers firmly and correctly according to the channel(left and right) and the polarity(+ and -). If the connections are faulty, no sound will be heard from the speakers, and if the polarity of the speaker connection is incorrect, the sound will be unnatural and lack bass.
- For installing the speakers, refer to “Speaker placement” on page 11.
- After installing the speakers, first adjust the speaker settings according to your environment and speaker layout.(For details, refer to “SETTING THE SPEAKER SETUP” on page 45.)
- You can connect the surround and the surround back speakers with various combinations according to the usage purpose.

■Surround speakers A and B

- This unit allows you to connect two different sets of surround speakers and to place them in the appropriate locations in your room, resulting in enjoying both movie soundtracks and music listening with optimum surround sound and no compromise.
- However, if you have only a set of surround speakers, connect them to either SURROUND A or SURROUND B SPEAKER terminals according to your taste.

■Surround back speakers

- When using only one surround back speaker, you should connect it to SURROUND BACK LEFT channel. In this case, you can connect a subwoofer without built-in amplifier to SURROUND BACK RIGHT channel.(For details, refer to “When selecting the SUBWOOFER” on page 49.)
- If you assign the power amplifier for the surround back channels to the ROOM 2, this unit can drive the speakers in another room (ROOM 2).
(For details, refer to “ROOM 2 connections” on page 12. and “SETTING THE POWER AMP ASSIGN” on page 45.)

Caution :

- For safe amplifier operation, in case of using either surround A or surround B speakers, use all the speakers with impedance of over 6 ohms. However, in case of using both surround A and surround B speakers, use only these speakers with impedance of over 12 ohms and other speakers with impedance of over 6 ohms.
- Do not let the bare speaker wires touch each other or any metal part of this unit. This could damage this unit and/or the speakers.

Speaker placement

Ideal speaker placement varies depending on the size of your room and the wall coverings, etc. The typical example of speaker placement and recommendations are as follows :

■ Front left and right speakers and center speaker

- Place the front speakers with their front surfaces as flush with TV or monitor screen as possible.
- Place the center speaker between the front left and right speakers and no further from the listening position than the front speakers.
- Place each speaker so that sound is aimed at the location of the listener's ears when at the main listening position.

■ Surround speakers A and B

- To achieve more effective surround sound for both movies and music , connect two different sets of surround speakers and place them in the appropriate locations for two types of sources as follows :
 - Surround speakers A :
For watching movies, place the surround speakers A approximately 1 meter (40 inches) above the ear level of a seated listener on the direct left and right of them or slightly behind.
 - Surround speakers B :
For playing multi-channel music , place the surround speakers B at the same height as the front speakers and slightly at an angle to the rear of the listening position , and point them toward the listening position .

■ Surround back left and right speakers

- Place the surround back speakers at the back facing the front at a narrower distance than front speakers.
- When using a single surround back speaker, place it at the rear center facing the front at a slightly higher position (0 to 20 cm) than the surround speakers.
- We recommend installing the surround back speaker(s) at a slightly downward facing angle. This effectively prevents the surround back channel signals from reflecting off the TV or screen at the front center, resulting in interference and making the sense of movement from the front to the back less sharp.

■ Subwoofer

- The subwoofer reproduces powerful deep bass sounds.
Place a powered subwoofer anywhere in the front as desired.

■ Notes :

- When using a conventional TV , to avoid interference with the TV picture, use only magnetically shielded front left and right and center speakers.
- To obtain the best surround effects, the speakers except the subwoofer should be full range speakers.

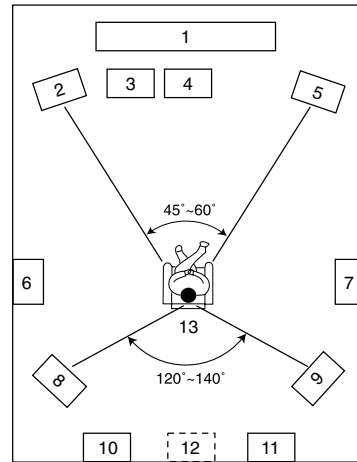

- | | |
|-----------------------------|---------------------------------|
| 1. TV or screen | 8. Surround left speaker B |
| 2. Front left speaker | 9. Surround right speaker B |
| 3. Subwoofer | 10. Surround back left speaker |
| 4. Center speaker | 11. Surround back right speaker |
| 5. Front right speaker | 12. Surround center speaker |
| 6. Surround left speaker A | 13. Listening position |
| 7. Surround right speaker A | |

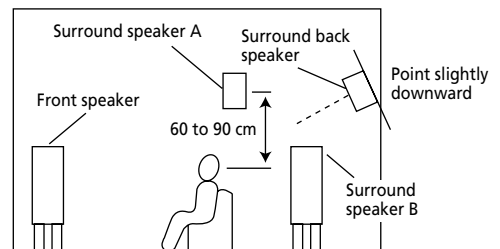

8. CONNECTING SYSTEM CONTROL

- Connect this jack to the DIGI LINK jack of the external Sherwood component that uses the DIGI LINK II or III remote control system.

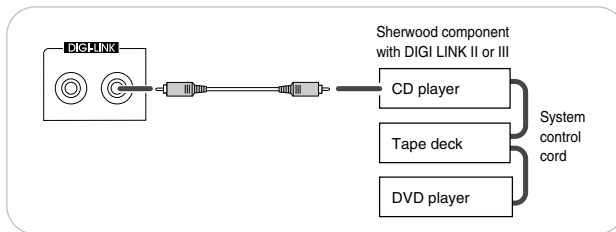

9. CONNECTING DC TRIGGER OUTS

- Connect components that need to be triggered by DC under certain conditions as follows :
- Connect a component to DC TRIGGER OUT 1 jack that allows DC 12 V to turn on or off when this unit's power is turned on or off.
- Connect a component to DC TRIGGER OUT 2 jack that allows DC 12 V to turn on or off when a specific input source is selected or not.
- For details, refer to the operating instructions of the components to be connected.
- To link DC TRIGGER OUT 2 with a specific input source, refer to "When selecting the DC TRIGGER 2 SETUP" on page 57.

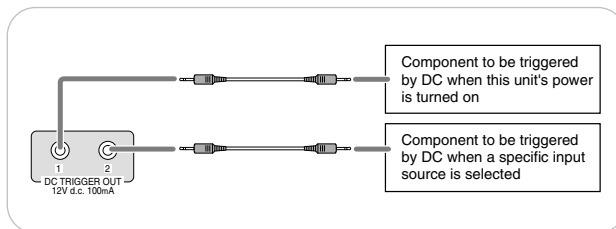

■Notes :

- This output voltage (12 V d.c., 100mA) is for (status) control only, it is not sufficient for drive capability.
- When making DC TRIGGER connection, you should use the stereo mini cord, not a mono mini cord.

■ROOM 2 connections

- ROOM 2 playback feature allows you to play a different program source in another room as well as one source in the main room at the same time.
- For ROOM 2 playback, connect the VIDEO 2 / ROOM 2 OUT jacks and the COAXIAL DIGITAL OUT to the amplifier, TV, etc. installed in another room, or connect the SURROUND BACK speaker terminals to the speakers.
- In case of using a pair of speakers only, you should assign the power amplifier for surround back channels to the ROOM 2. (For details, refer to "SETTING THE POWER AMP ASSIGN" on page 45.)

■Note :

- To minimize hum or noise, use high quality connection cords.

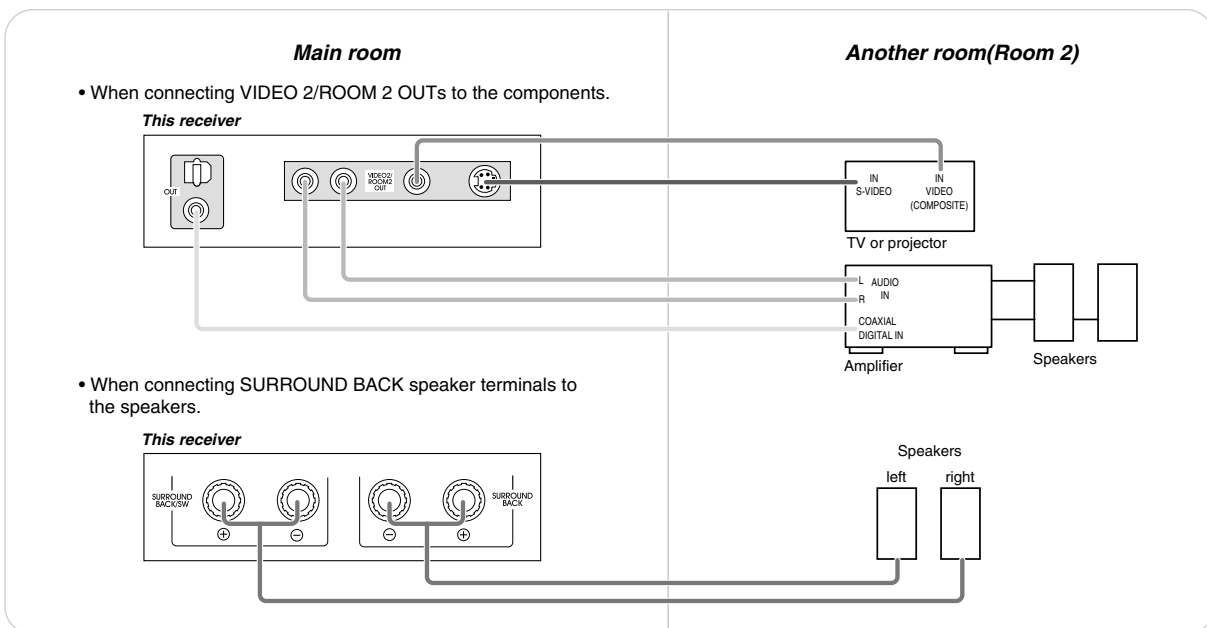

10. CONNECTING MULTI-ROOM SYSTEM KIT

- The multi-room system kit(sold separately) is essential for operation from a remote location .
For information on the multi-room system kit, contact the Xantech corporation at 1-800-843-5465 or www.xantech.com.
- IR IN jack allow you to control this receiver from another room with the remote control unit.
- To control this receiver from another room with the remote control unit, connect the IR IN jack to the output of the connecting block.
- If this receiver is located inside a cabinet or other enclosure where the infrared beams from the remote control unit cannot enter, then operation with the remote control unit will not be possible. In such a case, connect the IR IN jack to the output of the connecting block.
- To control other compatible component from another room with the universal remote control unit, connect the IR OUT jack to the IR emitter.
- Note:
 - Remote operation may become unreliable if the IR receiver is exposed to strong light such as direct sunlight or inverted fluorescent.

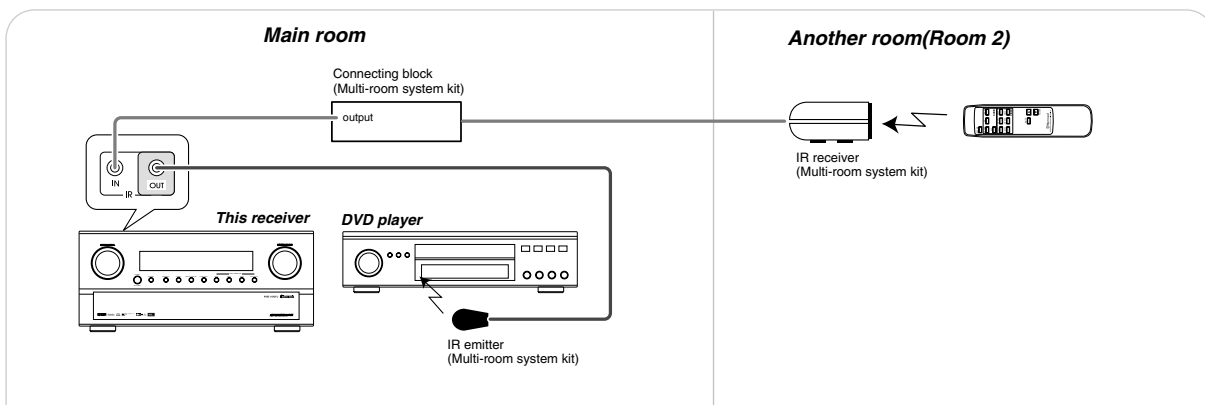

- When this receiver is located inside a cabinet.

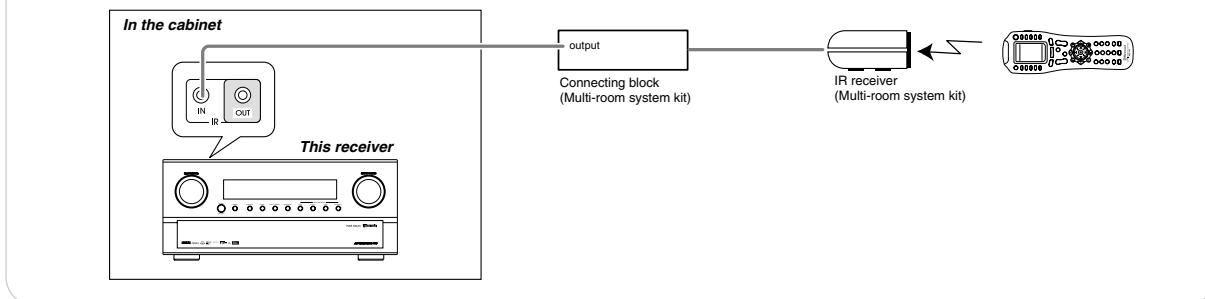

11. CONNECTING MICROPHONE

- To use Auto Speaker Setup function, connect the supplied microphone to the SETUP MIC jack.(For details, refer to "When selecting the AUTO SPEAKER SETUP" on page 51.)
- Notes:
 - Because the microphone for Auto Speaker Setup is designed for use with this receiver, do not use a microphone other than the one supplied with this receiver.
 - After you have completed the auto speaker setup procedure, disconnect the microphone.

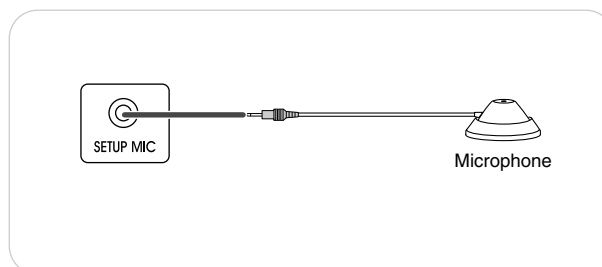

12. CONNECTING PC FOR UPGRADES

- This receiver incorporates USB as well as RS-232C terminal that may be used in the future to update the operating software so that it will be able to support new digital audio formats, external control by using an external device and the like.
- Connect either USB or RS-232C terminal to your PC(You don't need to do both).

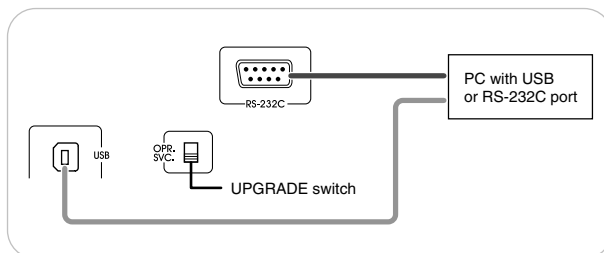

■Notes :

- Be sure to set the UPGRADE switch to “SVC”(service) before updating.
- This switch should be set to “OPR”(operation) during normal operation except for upgrades. If not, this unit will not operate normally.
- Programming for upgrades and external control requires specialized programming knowledge and for that reason we recommend that it only be done by qualified installers. For more information on future upgrades and external control, visit the Sherwood web site at www.sherwoodamerica.com or contact your dealer.
- Do not disconnect the connection cable while updating the operating software, etc. Should this happen, it may result in malfunction or cause damage to the unit.

13. SWITCHED AC OUTLETS

- These outlets are switched on(power-on mode) and off(standby mode) according to power control as follows(Maximum total capacity is 100 W, 1 A).

- Standby mode - Switched AC outlet off
- Power-on mode - Switched AC outlet on

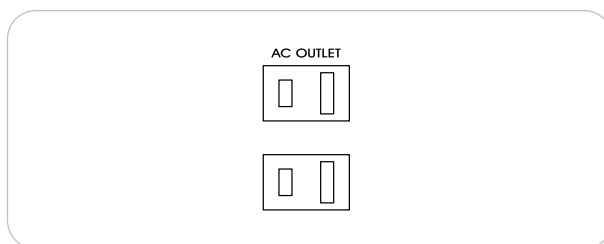

14. AC INLET

- Plug the supplied AC input cord into this AC INLET and then into the wall AC outlet.

■Note:

- Do not use an AC input cord other than the one supplied with this unit. The AC input cord supplied is designed for use with this unit and should not be used with any other device.

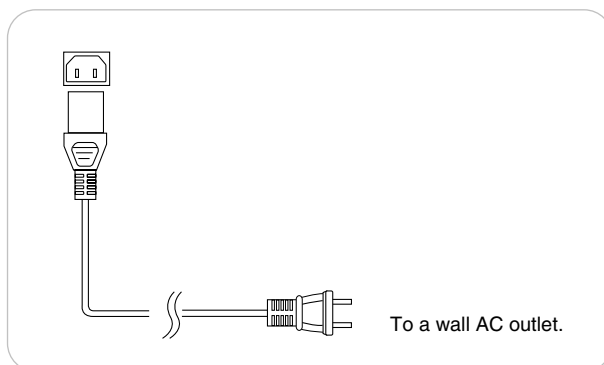

Front Panel Controls

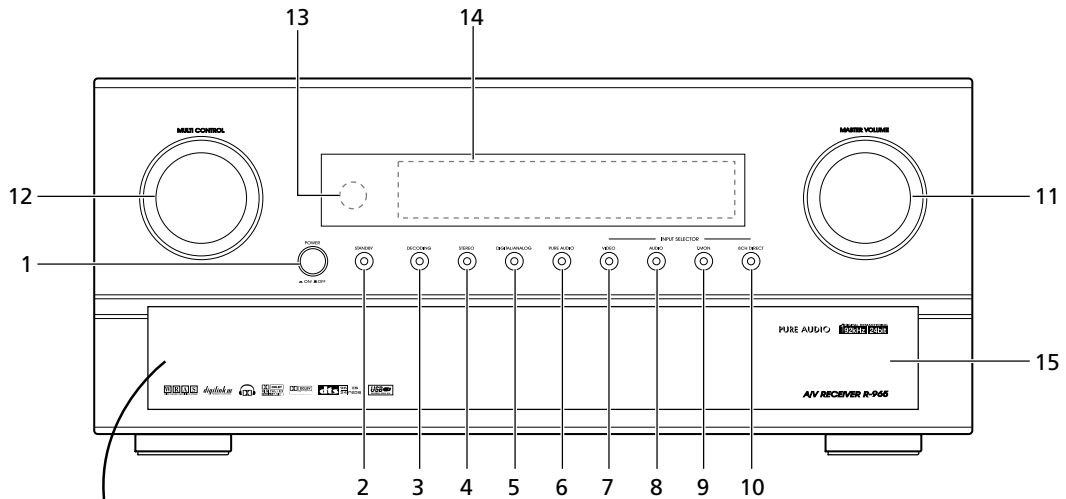

• To open the panel door, push gently on the lower third of the panel door.

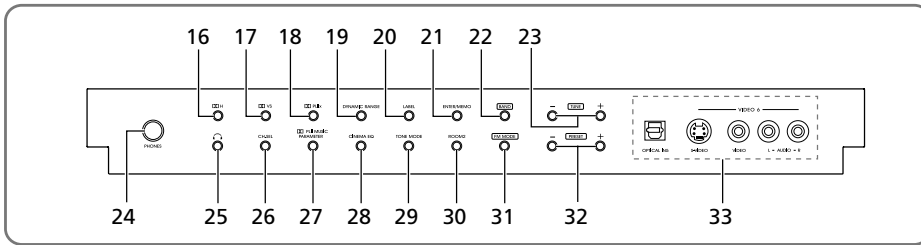

- | | |
|--|--|
| <ul style="list-style-type: none"> 1. POWER switch 2. STANDBY button/indicator 3. DECODING MODE button 4. STEREO button 5. DIGITAL/ANALOG button 6. PURE AUDIO button 7. VIDEO SELECTOR button 8. AUDIO SELECTOR button 9. TAPE MONITOR button 10. 8 CH DIRECT button 11. MASTER VOLUME CONTROL knob 12. MULTI CONTROL knob 13. REMOTE SENSOR 14. FLUORESCENT DISPLAY
For details, see next page. 15. PANEL DOOR 16. DOLBY HEADPHONE button 17. DOLBY VIRTUAL SPEAKER button 18. DOLBY PL IIx button 19. DYNAMIC RANGE button | <ul style="list-style-type: none"> 20. LABEL button 21. ENTER/MEMORY button 22. BAND button 23. TUNING UP(+)/DOWN(-) buttons 24. HEADPHONE jack 25. HEADPHONE SELECTOR button 26. CHANNEL SELECTOR button 27. DOLBY PL II MUSIC PARAMETER button 28. CINEMA EQ button 29. TONE MODE button 30. ROOM 2 button 31. FM MODE button 32. PRESET UP(+)/DOWN(-) buttons 33. VIDEO 6 INPUT jacks
For details, see next page. |
|--|--|

■ FLUORESCENT DISPLAY

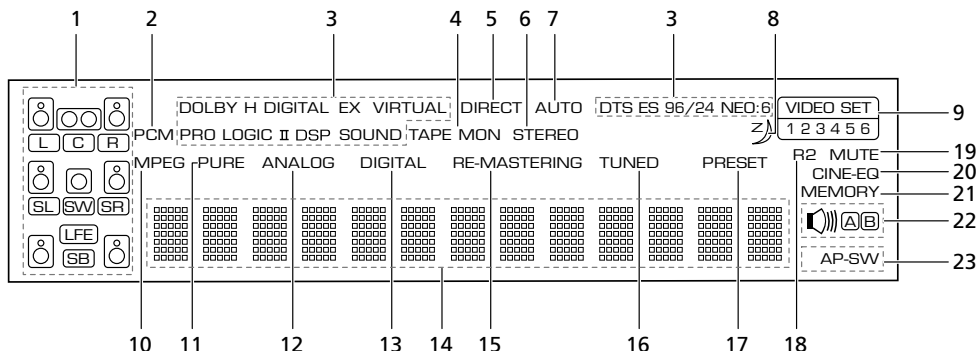

- | | |
|-----------------------------|---|
| 1. CHANNEL indicators | 13. DIGITAL INPUT indicator |
| 2. PCM SIGNAL indicator | 14. Input, frequency, volume level, operating information, etc. |
| 3. SURROUND MODE indicators | 15. RE-MASTERING indicator |
| 4. TAPE MONITOR indicator | 16. TUNED indicator |
| 5. DIRECT indicator | 17. PRESET indicator |
| 6. STEREO indicator | 18. ROOM 2 indicator |
| 7. AUTO indicator | 19. MUTE indicator |
| 8. SLEEP indicator | 20. CINEMA EQ indicator |
| 9. VIDEO INPUT indicators | 21. MEMORY indicator |
| 10. MPEG SIGNAL indicator | 22. SURROUND A/B indicators |
| 11. PURE AUDIO indicator | 23. SUBWOOFER indicators |
| 12. ANALOG INPUT indicator | |

■ VIDEO 6 INPUT JACKS

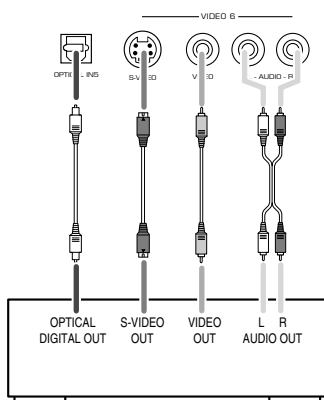

VIDEO 6 Camcorder, video game player, etc.

- The VIDEO 6 input jacks may be also connected to an additional video component such as a camcorder, a video game player, etc.
- If the OPTICAL IN 5 is connected to the component connected to VIDEO 6, it is easier to do so following the default settings. (For details, refer to "Digital input default settings" on page 8.)
- If the OPTICAL IN 5 connection is different from the default settings, you should assign the DIGITAL INs you used with the "When selecting the DIGITAL INPUT SETUP" procedure on page 53.

Universal Remote Controls

This universal remote control can operate not only this receiver but also most popular brands of audio and video components such as CD players, DVD players, tape decks, TVs, VCRs, satellite receivers, cable boxes, etc.

- To operate 8 components other than this receiver, you should enter the setup code for each component. (For details, refer to "ENTERING A SETUP CODE" on page 21)
- The numbered buttons on the remote control have different functions in different device modes. For details, refer to "FUNCTION TABLE of the NUMBERED BUTTONS" on the next page.

■ Note :

- This section explains the basic operations to control this receiver and other Sherwood components with this remote control. For various and convenient functions of this remote control , refer to the operating manual inclosed with this remote control.

■ DIGI LINK system remote controls

This remote control can also operate Sherwood compatible components bearing the DIGI LINK(II or III) logo.

- For DIGI LINK system remote control operation, first make the DIGI LINK connections between Sherwood components.
- In the DIGI LINK III remote control system, if pressing PLAY, etc. on CD player or tape deck, CD or TAPE MONITOR is selected automatically on the receiver without selecting the input source. Then PLAY, etc. starts.

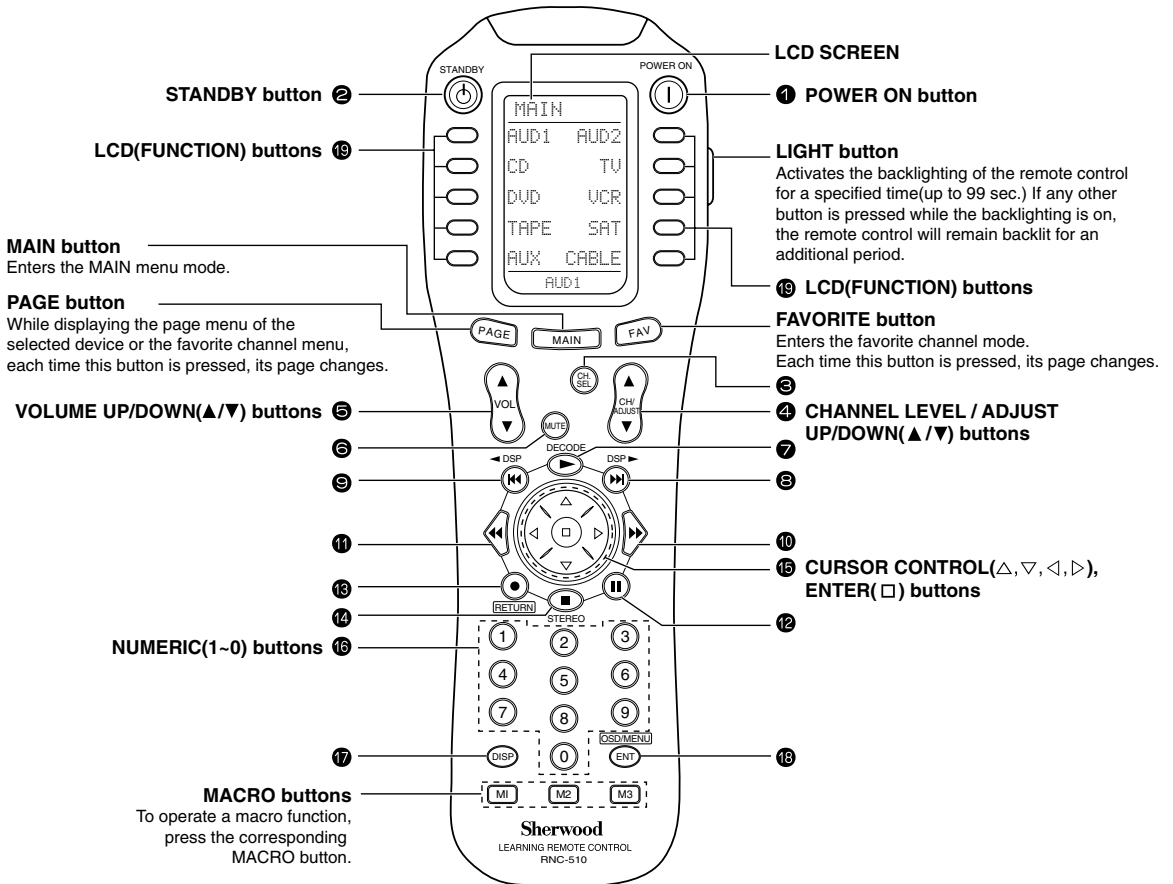

■FUNCTION TABLE of the NUMBERED BUTTONS.

Button symbol	Device to be controlled	AUDIO 1("AUD1") (for receiver, "001")	AUDIO 2("AUD2") (for receiver, "001")	CD (for CD player, "001")	TAPE (for tape deck, "001")	TV (for TV, "001")
1		POWER ON	POWER ON	<POWER ON>	<POWER ON>	POWER ON
2		STANDBY	STANDBY	<STANDBY>	<STANDBY>	STANDBY
3		CHANNEL SELECTOR	CHANNEL SELECTOR	<CHANNEL SELECTOR>	<CHANNEL SELECTOR>	PREVIOUS CHANNEL
4		CH LEVEL/ADJUST UP(▲)	CH LEVEL/ADJUST UP(▲)	<CH LEVEL/ADJUST UP(▲)>	<CH LEVEL/ADJUST UP(▲)>	CHANNEL UP(▲)
		CH LEVEL/ADJUST DOWN(▼)	CH LEVEL/ADJUST DOWN(▼)	<CH LEVEL/ADJUST DOWN(▼)>	<CH LEVEL/ADJUST DOWN(▼)>	CHANNEL DOWN(▼)
5		VOLUME UP(▲)	VOLUME UP(▲)	<VOLUME UP(▲)>	<VOLUME UP(▲)>	VOLUME UP(▲)
		VOLUME DOWN(▼)	VOLUME DOWN(▼)	<VOLUME DOWN(▼)>	<VOLUME DOWN(▼)>	VOLUME DOWN(▼)
6		MUTE	MUTE	<MUTE>	<MUTE>	MUTE
7		DECODING MODE	DECODING MODE	PLAY	FORWARD PLAY	—
8		DSP MODE UP(▶)	DSP MODE UP(▶)	—	—	SURROUND MODE
9		DSP MODE DOWN(◀)	DSP MODE DOWN(◀)	—	—	—
10		—	—	FORWARD SKIP	FAST FORWARD	—
11		—	—	REVERSE SKIP	REWIND	—
12		—	—	PAUSE	PAUSE	—
13		RETURN	RETURN	—	RECORD	—
14		STEREO	STEREO	STOP	STOP	LANGUAGE
15		CURSOR CONTROL	CURSOR CONTROL	<CURSOR CONTROL>	<CURSOR CONTROL>	CURSOR CONTROL
		ENTER	ENTER	<ENTER>	<ENTER>	ENTER
16		0-9	0-9	0-9	<0-9>	0-9
17		DISPLAY	DISPLAY	<DISPLAY>	<DISPLAY>	—
18		OSD	OSD	<OSD>	<OSD>	MENU
P A G E 1	(Left 1)	TUNER	SLEEP	PLAY	DECK SELECTOR A	—
	(Left 2)	CD	DIMMER	REVERSE SKIP	REVERSE PLAY	SLEEP
	(Left 3)	TAPE MONITOR	ROOM 2	STOP	RECORD	CAPTION
	(Left 4)	AUX	TEST TONE	REPEAT A< >B	REWIND	—
	(Left 5)	PHONO	OSD	—	STOP	—
	(Right 1)	VIDEO 1	DIGITAL/ANALOG	PAUSE	DECK SELECTOR B	—
	(Right 2)	VIDEO 2	SURROUND A/B	FORWARD SKIP	FORWARD PLAY	AUTO SET
	(Right 3)	VIDEO 3	SURROUND BACK	INTRO SCAN	PAUSE	ADD/ERASE
	(Right 4)	VIDEO 4	PURE AUDIO	—	FAST FORWARD	—
	(Right 5)	VIDEO 5	PL II MUSIC PARAMETER	—	—	—
P A G E 2	(Left 1)	VIDEO 6	SEARCH MODE	<SLEEP>	<SLEEP>	PIP
	(Left 2)	DTS	PTY SELECT	<DIMMER>	<DIMMER>	SWAP
	(Left 3)	DOLBY DIGITAL	MEMORY	<ROOM 2>	<ROOM 2>	SOURCE
	(Left 4)	PCM	TUNING UP(+)	<TEST TONE>	<TEST TONE>	—
	(Left 5)	MPEG	TUNING DOWN(-)	<OSD>	<OSD>	—
	(Right 1)	8 CH DIRECT("7.1 IN")	EON TA	<DIGITAL/ANALOG>	<DIGITAL/ANALOG>	—
	(Right 2)	PL II MOVIE	EON PTY	<SURROUND A/B>	<SURROUND A/B>	STILL
	(Right 3)	PL II MUSIC	PRESET SCAN	<SURROUND BACK>	<SURROUND BACK>	—
	(Right 4)	NEO 6 CINEMA	PRESET UP(+)	<PURE AUDIO>	<PURE AUDIO>	—
	(Right 5)	NEO 6 MUSIC	PRESET DOWN(-)	<PL II MUSIC PARAMETER>	<PL II MUSIC PARAMETER>	—

■Notes :

- To control this receiver completely with this remote control, you should use "AUD 1" and "AUD 2" both and "001" should be entered respectively as their setup codes.
- The functions in < > work for this receiver, not for the CD player or tape deck.

Continued

Button symbol	Device to be controlled	DVD(for DVD player)		
		V-768, etc.('001')	VD-4106, etc.('091')	VD-8300, etc.('116')
1		POWER ON	POWER	POWER
2		STANDBY	—	—
3		—	—	DIGEST
4		—	—	—
		—	—	—
5		—	—	VOLUME UP(▲)
		—	—	VOLUME DOWN(▼)
6		—	—	—
7		PLAY	PLAY	PLAY/PAUSE
8		FORWARD SKIP	FORWARD SKIP	FORWARD SKIP
9		REVERSE SKIP	REVERSE SKIP	REVERSE SKIP
10		FORWARD SEARCH	FORWARD SEARCH	FORWARD SEARCH
11		REVERSE SEARCH	REVERSE SEARCH	REVERSE SEARCH
12		PAUSE	PAUSE	STEP
13		RETURN	RETURN	—
14		STOP	STOP	STOP/RETURN
15		CURSOR CONTROL	CURSOR CONTROL	CURSOR CONTROL
		ENTER	ENTER/SELECT	ENTER/SELECT
16		0-9	0-9	0-9
17		DISPLAY	DISPLAY	DISPLAY
18		MENU	—	—
19 P A G E 1	(Left 1)	SETUP	SETUP	SETUP
	(Left 2)	TITLE	TITLE	TITLE
	(Left 3)	AUDIO	AUDIO	AUDIO
	(Left 4)	SUBTITLE	SUBTITLE	SUBTITLE
	(Left 5)	DISC SKIP	SOUND	3D SOUND
	(Right 1)	OPEN/CLOSE	OPEN/CLOSE	OPEN/CLOSE
	(Right 2)	ZOOM	ZOOM	ZOOM
	(Right 3)	SEARCH	SEARCH	PBC
	(Right 4)	REPEAT A< >B	REPEAT A< >B	REPEAT A< >B
	(Right 5)	REPEAT MODE	REPEAT	REPEAT
19 P A G E 2	(Left 1)	MARKER	MARKER	MARKER
	(Left 2)	INTRO SCAN	RESUME	—
	(Left 3)	RANDOM	RANDOM	SHUFFLE
	(Left 4)	SUBTITLE	—	—
	(Left 5)	ANGLE	ANGLE	ANGLE
	(Right 1)	PROGRAM	PROGRAM	PROGRAM
	(Right 2)	CLEAR	CLEAR	CLEAR
	(Right 3)	TIME	REVERS SLOW	—
	(Right 4)	SLOW	FORWARD SLOW	—
	(Right 5)	PAL/NTSC	—	—

■Notes :

- Some functions for each component may not be available or may work differently .
- For details about functions , refer to the operating instructions of each component .

OPERATING COMPONENTS WITH REMOTE CONTROL

1

Enter the setup code of the components respectively, referring to "ENTERING A SETUP CODE" (page 21).

2

Turn on the components you want to operate.

3

Select the device on the main menu of the remote control corresponding to the component you want to operate.

Example) When selecting "AUD 1" or "AUD 2" to operate this receiver.

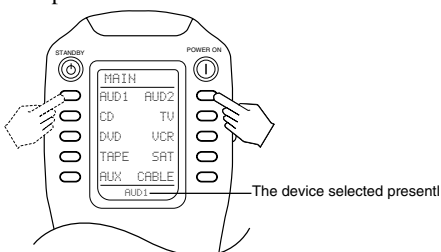

• Then the page menu of the selected device will be displayed.

4

Press the button corresponding to the operation you want while aiming the remote control at the REMOTE SENSOR on the component.

- When operating a Sherwood CD player or tape deck using the system remote control, aim the remote control at the REMOTE SENSOR on this unit.
- However, in case of Sherwood DVD player or TV, aim it at the REMOTE SENSOR on the corresponding component.
- In case of selecting a function on the page menu of the selected device.
- Find a function with pressing the PAGE button repeatedly and then press the button corresponding to the desired function.

Example) when selecting a function on the AUD 1's page menu.

Functions on the page 1

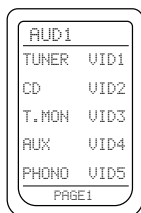

Functions on the page 2

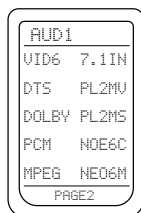

REMOTE CONTROL OPERATION RANGE

- Use the remote control within a range of about 7 meters (23 feet) and angles of up to 30 degrees aiming at the remote sensor.

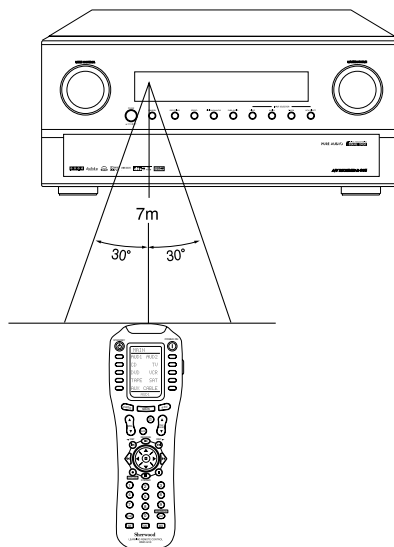

LOADING BATTERIES

- When the remote control does not operate or "LOW BATTERY" is displayed on the LCD screen, etc., the old batteries should be replaced.

1

Remove the cover.

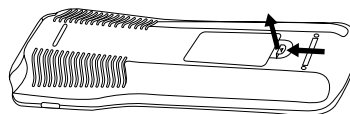

2

Load four alkaline batteries ("AAA" size, 1.5V) matching the polarity.

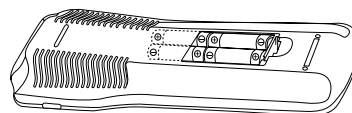

ENTERING A SETUP CODE

- This remote control can control up to ten different components.
 - Before operating audio and video components using the remote control supplied with this receiver, the setup code for each component should be entered.
 - For system remote control operation between Sherwood components, "001" was stored previously in the memory of each device such as "AUD 1" and "AUD 2" for this receiver, "CD" for CD player, "TAPE" for tape deck, "TV" for TV and "DVD" for DVD player.
- So, you don't need to enter its code for each Sherwood component except in such a case that its code does not work. (When entering each setup code for Sherwood CD player and tape deck, do from the below step ③.)

1

Turn on the component you want to control.

■Note:

- If your component has the discrete POWER ON and OFF(STADNBY) buttons, please do not turn on the component manually.

Example) When entering the setup code for this receiver, turn off this receiver.

2

Find the setup code for your component referring to "Set-Up Code Table" in the operating manual of this remote control.

Example) The 3 digit setup codes for the Sherwood "Audio" are 001,024, ... (Hint: The correct setup code for this receiver is "001".)

3

Press both the MAIN and OSD/MENU (/ENTER) buttons simultaneously for 3 seconds.

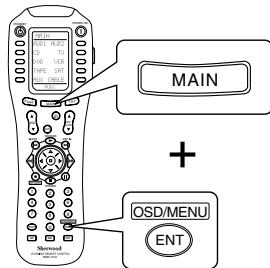

- Then the setup menu will be displayed on the LCD screen.

■Note:

- If the display of the corresponding mode disappears, start again from the above step ③ or the current mode.

4

Select the Pre-PROgramming mode.

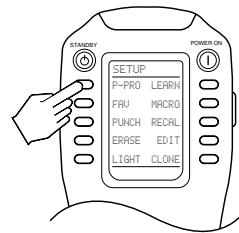

- Then the Pre-PROgramming menu will be displayed.

5

Select the device corresponding to the component you want to control.
Example) When selecting the "AUD 1" for this receiver or amplifier, etc.

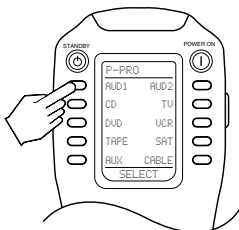

6

Select the device from which the appropriate 3 digit setup code table will be selected.
Example) If it is the "AUD 1" code table, select the "AUD 1".

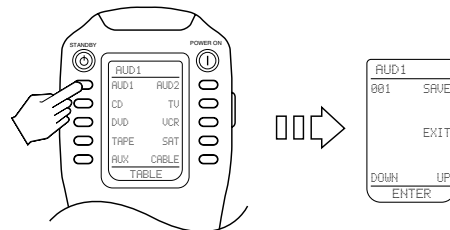

7 Enter the 3 digit setup code aiming the remote control at the REMOTE SENSOR on the component.

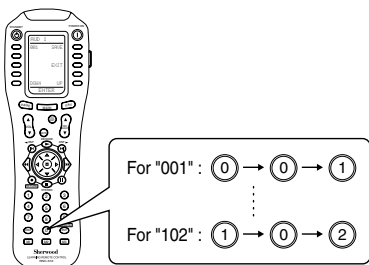

- Your component will be turned off (or on in case of this receiver, etc.) when the right code is entered.
- Continue to enter the corresponding codes until your component turns off (or on).

8 Confirm that it is the right code by selecting the SAVE.

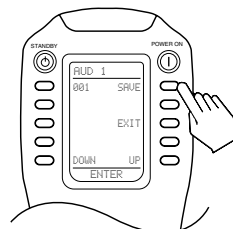

- The code is saved and the Pre-PROGRAMMING mode is resumed.
- When you do not want to save the code, select the EXIT on the LCD screen or press the MAIN button.

9 To resume the MAIN menu mode, press the MAIN button twice briefly.

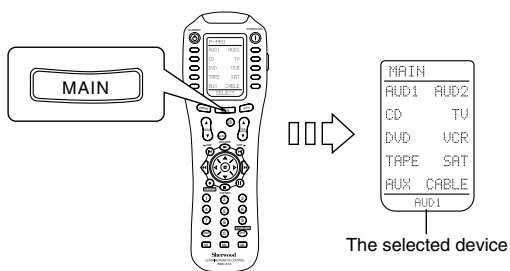

- Each time the MAIN button is pressed, the previous mode is resumed.

10 Operate the component using the corresponding function buttons.

- If any of the buttons fails to operate as they should, start from the step ① again to enter the next setup code.

■ Notes:

- If the Manufacturer/Brand for your component is not listed in "Set-Up Code Table" in the operating manual of this remote control, please use the "2 Auto Scan Method" on page 13 in the operating manual of this remote control.
- Although each setup code is designed to work with many different modes, certain codes may not work with some models. (Also, certain codes may only operate some of the functions available on a given model.)

11 Repeat the above steps ① to ⑩ for each of your other components.

ROOM 2 Remote Controls

This remote control unit is an additional remote control unit for the ROOM 2 source playback only.

- You can use the ROOM 2 functions with this remote control unit more conveniently in another room than with the universal remote control unit.

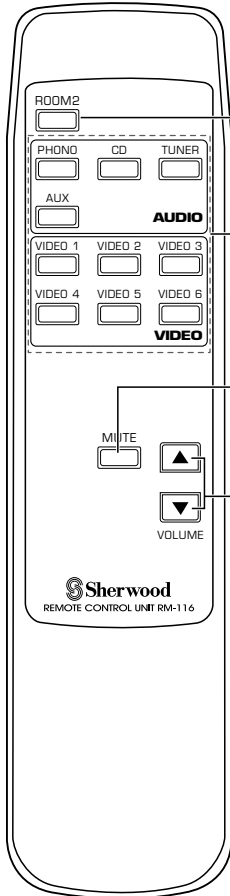

ROOM 2 BUTTON

Each time this button is pressed, the ROOM 2 function is activated or canceled.

ROOM 2 INPUT SELECTOR BUTTONS

When one of these buttons is pressed, the corresponding input source is selected.

MUTE BUTTON

Mutes the sound of the ROOM2 source.
 • To resume the previous sound level, press it again.

VOLUME UP/DOWN(▲/▼) BUTTONS

Adjust the sound volume of the ROOM 2 source.

REMOTE CONTROL OPERATION RANGE

- Aim the ROOM 2 remote control(or the universal remote control) at the IR receiver installed in another room.(For details, refer to “CONNECTING MULTI-ROOM SYSTEM KIT” on page 13.)

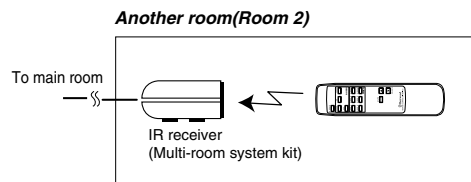

- When you operate the ROOM 2 function in the main room, aim the universal remote control(or the ROOM 2 remote control) at the remote sensor of this receiver.

LOADING BATTERIES

1

Remove the cover.

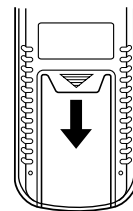

2

Load two batteries (“AAA” size, 1.5V) matching the polarity.

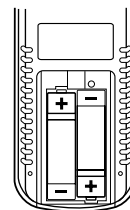

Operations

- Notes : • Before operating this receiver with the supplied remote control, refer to “ Universal Remote Controls” on page 17 for details about operation.
- Before operating this receiver, first set this unit as desired for optimum performance, doing the OSD menu setting procedures. (For details, refer to “OSD Menu Settings” on page 43.)

LISTENING TO A PROGRAM SOURCE

Before operation

- Enter the standby mode.
- The STANDBY button lights up in amber. This means that the receiver is not disconnected from the AC mains and a small amount of current is retained to support the operation readiness.
- To switch the power off, push the POWER switch again.
- Then power is cut off and the STANDBY button goes off.



1

In the standby mode, turn the power on.

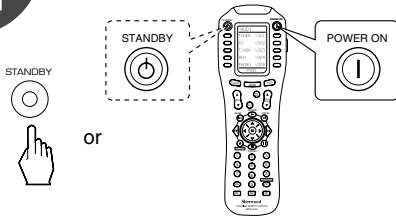



- Each time the STANDBY button on the front panel is pressed, the receiver is turned on to enter the operating mode (the STANDBY button lights up in blue) or off to enter the standby mode (the STANDBY button lights up in amber).
- On the remote control, press the POWER ON button to enter the operating mode or press the STANDBY button to enter the standby mode.
- In the standby mode, if the INPUT SELECTOR button is pressed, the receiver is turned on automatically and the desired input is selected.

2

Switch the speakers on.



- Then the SPEAKER indicator () lights up and the sound can be heard from the speakers.
- When using the headphones for private listening, press this button again to switch the speakers off, then the SPEAKER indicator () goes off (speaker off mode).

3

Select the desired input source.

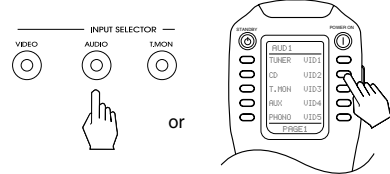

- Each time the “AUDIO” button is pressed, the input source changes as follows:

→ PHONO → TUNER → CD → AUX
(frequency display)

- Each time the “VIDEO” button is pressed, the input source changes as follows:

→ VIDEO 1 → VIDEO 2 → ----- → VIDEO 6

- When the TAPE MONITOR button is set to on so that “TAPE MON” lights up, other inputs can not be heard from the speakers.

To listen to an input source except TAPE MONITOR, be sure to set the TAPE MONITOR button to off.

TAPE MONITOR function

You can connect either a tape deck or a graphic equalizer to the receiver’s TAPE MONITOR jacks.

Only when you listen to the component connected to these jacks, set the TAPE MONITOR button to on.

If you connect a 3-head tape deck, you can listen to the sound being recorded during recording, not the source sound.

For further details, refer to the operating instructions of the component connected.

■ When selecting the 8 CH DIRECT as desired

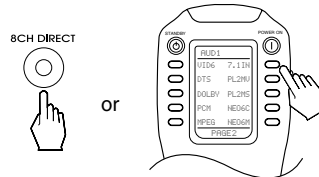

- Depending on the power amplifier setting for the surround back channels and the surround back speaker setting, “8(, 7 or 6) CH DIRECT” is displayed and the 8(7/6) separate analog signals from the component connected to this input pass through the tone, volume and bass management (if selected) circuits only and can be heard from your speakers. (In case that the TAPE MONITOR button is set to on, the TAPE MONITOR button is automatically set to off.)
- Press the 8 CH DIRECT button or select the desired input source to cancel the 8 CH direct function.
- These analog signals can be heard only. They cannot be recorded.

When CD, AUX or VIDEO 1~ VIDEO 6 is selected

4 Select the digital or the analog input as desired.

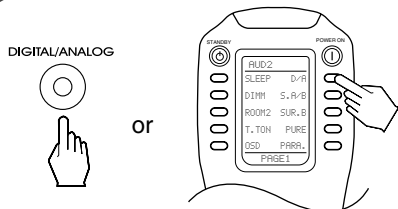

- Each time this button is pressed, the corresponding input is selected as follows:

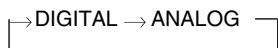

- When PHONO, TUNER or TAPE MONITOR is selected as an input source, the analog input is automatically selected.
- Notes:
 - When the selected digital input is not connected, “DIGITAL” is flickering, meaning no sound.(Refer to “ENJOYING SURROUND SOUND” on page 30.)
 - To select the digital input, you should assign the connected DIGITAL IN to the corresponding input source. (For details, refer to “When selecting the DIGITAL INPUT SETUP” on page 53.)

5 Operate the selected component for playback.

- When playing back the program sources with surround sound, refer to “ENJOYING SURROUND SOUND” on page 30.

6 Adjust the (overall) volume.

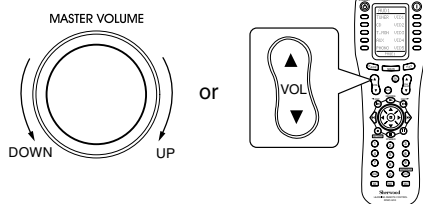

Adjusting the tone (bass and treble)

7 Select the tone mode as desired.

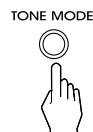

- Each time this button is pressed, the tone mode changes as follows:

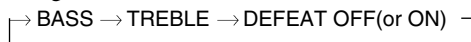

- The tone display is shown for several seconds.
- If the tone display disappears, press the TONE MODE button again.
- () : When the tone defeat function is activated (“DEFEAT ON”), bass and treble modes cannot be selected
- Note:
 - When the pure audio function is activated, the tone mode cannot be selected.

8 At the desired tone mode, adjust as desired.

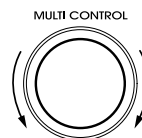

- At the tone defeat mode, each time the MULTI CONTROL knob is rotated, the tone defeat mode changes as follows:

DEFEAT ON : When listening to a program source
 ↓
 without the tone effect.
 DEFEAT OFF : When adjusting the tone for your taste.

- At the desired tone (bass or treble), each time the MULTI CONTROL knob is rotated, the tone level can be adjusted within the range of +10~ -10 dB.
- In general, we recommend the bass and treble to be adjusted to 0(flat) level.
- To complete tone adjustment, repeat the above steps ⑦ and ⑧.
- Extreme settings at high volume may damage your speakers.

Achieving higher purity of sound quality

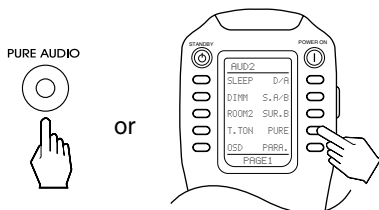

- Only when playing program sources recorded in either analog stereo or 2 channel PCM format, the pure audio function can be selected.
- “PURE” lights up and the stereo mode is automatically selected and all the video-related circuits as well as the digital processing circuits are turned off.
- Press this button again to cancel the pure audio function.
- When you select other input source or the other between digital and analog inputs, the pure audio function is automatically canceled.

Compensating for edgy or shrill movie sound tracks



- When the pure audio function is selected, the cinema EQ function can not be selected.
- “CINEMA-EQ ON” will scroll on the display.
- Press it again to cancel, then “CINEMA-EQ OFF” will scroll on the display.

Muting the sound

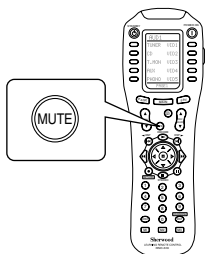

- “MUTE” lights up.
- To resume the previous sound level, press the button again.

Listening with the headphones



- Ensure that the HEADPHONE SELECTOR button is set to the speaker off mode.
- Depending on the signal format which is being input, you can listen in different Dolby Headphone modes, stereo mode, etc. with pressing the DOLBY HEADPHONE button. (For details, refer to “To listen in a Dolby Headphone mode” on page 32).

SURROUND SOUND

- This receiver incorporates a sophisticated Digital Signal Processor that allows you to create optimum sound quality and sound atmosphere in your personal Home Theater.

Surround modes

■ DTS Digital Surround

DTS Digital Surround(also called simply DTS) is a multi-channel digital signal format which can handle higher data rates. Discs bearing the “” include the recording of up to

5.1 channels of digital signals, which can be generally thought to provide better sound quality due to the lower audio compression required.

It also provides wide dynamic range and separation, resulting in magnificent sound.

■ DTS - ES Extended Surround™

This is a new multi channel digital signal format which greatly improves the 360- degree surround impression and space expression thanks to further expanded surround signals, offering high compatibility with the conventional DTS format. In addition to the 5.1 channels, DTS-ES Extended Surround also offers the surround back (sometimes also referred to as “surround center”) channel for surround playback with a total of 6.1 channels. DTS-ES Extended Surround includes two signal formats with different surround signal recording methods as follows:

• DTS-ES™ Discrete 6.1

Because the signals for 6.1 channels (including the surround back channel) are fully independent, it is possible to achieve a sense that the acoustic image are moving about freely among the background sounds surrounding the listener from 360 degrees. Though maximum performance is achieved when sound tracks recorded with this system are played using a DTS -ES decoder, when played with a conventional DTS decoder, the surround back channel signals are automatically downmixed to the surround left and surround right channels so that none of the signal components are lost.

• DTS - ES™ Matrix 6.1

With this format, the additional surround back channel signals undergo matrix encoding and are input to the surround left and surround right channels beforehand. During playback, they are decoded to the surround left, surround right and surround back channels. Because the bit stream format is 100% compatible with conventional DTS signals, the effect of the DTS-ES Matrix 6.1 format can be achieved even with DTS 5.1- channel signal sources. Of course, it is possible to play DTS-ES Matrix 6.1 - channel signal sources with a DTS 5.1 - channel decoder. When DTS-ES Discrete 6.1 or Matrix 6.1 sources are decoded with a DTS - ES decoder, the format is automatically detected upon decoding and the optimum surround mode is selected. However, some DTS - ES Matrix 6.1 sources may be detected as DTS sources. In this case, the DTS - ES Matrix mode should be selected manually to play these sources.

■ DTS Neo : 6™ surround

This mode applies conventional 2-channel signals such as digital PCM or analog stereo signals to the high precision digital matrix decoder used for DTS-ES Matrix 6.1 to achieve 6.1-channel surround playback. DTS Neo : 6 surround includes two modes for selecting the optimum decoding for the signal source.

• DTS Neo : 6 Cinema

This mode is optimum for playing movies. Decoding is performed with emphasis on separation performance to achieve the same atmosphere with 2-channel sources as with 6.1-channel sources.

• DTS Neo : 6 Music

This mode is suited mainly for playing music. The front left and front right signals bypass the decoder and are played directly so there is no loss of sound quality, and the effect of the surround signals from the center, surround left, surround right and surround back channels adds a natural sense of expansion to the sound field.

■ DTS 96/24

Conventional surround formats used sampling frequencies of 48 or 44.1 kHz, so 20 kHz was about the maximum playback signal frequency. With DTS 96/24, the sampling frequency is increased to 96 or 88.2 kHz to achieve a wide frequency range of over 40 kHz. In addition, this format has a resolution of 24 bits, resulting in the same frequency band and dynamic range as 96kHz / 24 bit PCM signals.

As with conventional DTS surround, DTS 96/24 is compatible with a maximum of 5.1 channels. DTS 96/24 is fully compatible with the conventional DTS surround format, so DTS 96/24 sources can be played using a conventional DTS 5.1 channel decoder.

“DTS”, “DTS-ES”, “DTS 96/24” and “Neo:6” are trademarks of Digital Theater Systems, Inc.

■ Dolby Digital

Dolby Digital is the multi- channel digital signal format developed by Dolby Laboratories. Discs bearing the “” includes the recording of up to 5.1 channels of digital signals, which can reproduce much better sound quality, spatial expansion and dynamic range characteristics than the previous Dolby Surround effect.

■ Dolby Digital EX

This mode creates the back (sometimes also referred to as “surround center”) signals from the surround left and right signals in Dolby Digital 5.1 channel source using a matrix decoder and provides 6.1 channel surround playback. For the best results, this mode should be selected during playback of sources(bearing the “”) recorded in Dolby Digital

EX. With this additional channel, you can experience more dynamic and realistic moving sound especially. When Dolby Digital EX sources are decoded with a Dolby Digital EX decoder, the format is automatically detected upon decoding and the Dolby Digital EX mode is selected. However, some Dolby Digital EX sources may be detected as Dolby Digital sources. In this case, the Dolby Digital EX mode should be selected manually to play these sources.

■Dolby Pro Logic IIx surround

Dolby Pro Logic IIx decodes all stereo (2 channel) and 5.1 channel sources and extends to 7.1channel surround playback. It delivers the most natural, full range and immersing 7.1 channel listening experience. Dolby Pro Logic IIx surround includes two modes as follows :

• **Dolby Pro Logic IIx Movie**

When enjoying movies, this mode allows you to further enhance the cinematic quality by adding processing that emphasizes the sounds of the action special effects.

• **Dolby Pro Logic IIx Music**

When listening to music, this mode allows you to further enhance the sound quality by adding processing that emphasizes the musical effects.

■Dolby Pro Logic II surround

This mode applies conventional 2-channel signals such as digital PCM or analog stereo signals as well as Dolby Surround signals, etc. to surround processing to offer improvements over conventional Dolby Pro Logic circuits. Dolby Pro Logic II surround includes Dolby Pro Logic II Movie and Dolby Pro Logic II Music like Dolby Pro Logic IIx surround.

■Dolby Virtual Speaker

This mode creates a virtual surround sound field using as few as two front speakers, allowing you to experience listening from 5.1 channel speakers.

This mode is effective not only for 5.1 channel sources but also for stereo (2 channel) sources.

■Dolby Headphone

The Dolby Headphone function simulates 5.1 channel surround sound , which allows you to enjoy 5.1 channel surround sound through 2 channel headphones, just like listening from 5.1 channel speakers.

This mode is effective not only for 5.1 channel sources but also for stereo (2 channel) sources.

Manufactured under license from Dolby Laboratories.

"Dolby", "Pro Logic" and the double-D symbol are trademarks of Dolby Laboratories.

■MPEG Multichannel

This mode is a surround system which faithfully reproduces the ambience and dynamics of movie soundtracks and music alike. Though the number of audio channels are same as Dolby Digital, discs bearing the " MPEG Multichannel " provides much better at locating individual sounds to the correct and stable position in the sound stage.

- The following modes apply conventional 2-channel signals such as digital PCM or analog stereo signals to high performance Digital Signal Processor to recreate sound fields artificially. Select one of the 13 provided surround modes according to the program source you want to play.

■Theater

This mode provides the effect of being in a theater -in-the round when watching a play.

■Movie

This mode provides the effect of being in a movie theater when watching a movie.

■Hall 1/2

This mode provides the ambience of a chamber hall for chamber music or an instrumental solo (Hall 1) or a concert hall for orchestral music or an opera (Hall 2).

■Stadium

This mode provides the expansive sound field to achieve the true stadium effect when watching baseball or soccer games.

■Church

This mode provides the ambience of a church for baroque, string orchestral or choral group music.

■Club 1/2

This mode creates the sound field of a jazz club with a low ceiling and hard walls (Club 1) or a live house with a relatively spacious floor (Club 2).

■Arena 1/2

This mode provides the feeling of a live concert in a medium - sized (Arena 1) or large (Arena 2) arena.

■Game

Use this mode to enjoy video game sources.

■4CH Stereo

This mode creates a wider, deeper and more natural soundstage from 2 channel PCM or analog stereo sources. The front left channel signals are output to the surround left channel and the front right channel signals are output to the surround right channel.

■Matrix

This mode reproduces a delayed signals from the surround channels to emphasize the sense of expansion for music sources.

- When using the 8 CH DIRECT INs to play back the sound from the additional multi-channel decoder for surround sound, you can enjoy the corresponding surround sound, too.(For details, refer to the operating instructions of the component to be connected.)

For your reference, the sound from each channel can be reproduced according to the surround modes as follows:

Modes \ Channels	FRONT L/R	CENTER	SURROUND L/R	SURROUND BACK L/R	SUBWOOFER
DTS, DTS 96/24	○	○	○	—	○
DTS ES DISCRETE/MATRIX	○	○	○	○	○
DTS NEO 6: CINEMA/MUSIC	○	○	○	○	—(*)
DOLBY DIGITAL	○	○	○	—	○
DOLBY DIGITAL EX	○	○	○	○	○
DOLBY PRO LOGIC IIx MOVIE/MUSIC	○	○	○	○	—(*)
DOLBY PRO LOGIC II MOVIE/MUSIC	○	○	○	—	—(*)
DOLBY VIRTUAL SPEAKER	○	○	○	—	—(*)
MPEG	○	○	○	—	○
4CH STEREO	○	—	○	—	—(*)
Other Surrounds	○	○	○	○	—(*)
STEREO	○	—	—	—	—(*)
8 CH DIRECT	○	○	○	○	○

(*): Depending on the subwoofer mode setting, the sound from the subwoofer channel may be reproduced.

- Depending on the speaker settings and the number of the encoded channels, etc. the sound from the corresponding channels cannot be reproduced.(For details, refer to "SETTING THE SPEAKER SETUP" on page 45.)

ENJOYING SURROUND SOUND

- Surround sound effect will not work properly if the signal passes through a graphic equalizer. Please refer to your equalizer operating instructions for guidance on switching off (or defeating) the equalizer.
- Note: Before surround playback, first perform the SPEAKER SETUP procedure, etc. on the OSD menu for optimum performance. (For details, refer to “SETTING THE SPEAKER SETUP” on page 45.)

1

Depending on the input digital signal format, select the desired decoding mode.

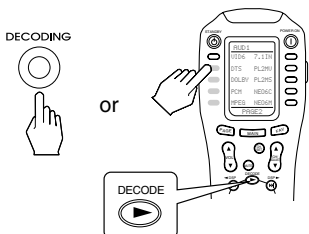

■Notes :

- Only when the digital input is selected as signal input for the input sources except PHONO, TUNER and TAPE MONITOR, the decoding mode can be selected.
- Noise may be generated at the beginning of playback and while searching during DTS playback in the auto mode. In this case, try playing in the DTS mode.

- You can select the “DTS”, “DOLBY DIGITAL”, “PCM” or “MPEG” mode directly on the remote control.
- Each time the DECODING MODE button is pressed, the decoding mode changes as follows :
 - * Auto mode(“AUTO” lights up): The input digital signal format (DTS, Dolby Digital, MPEG or PCM(2 channel stereo), etc.) used by the selected digital input source is detected automatically to perform the necessary decoding process for optimum surround mode.
 - * Dolby Digital mode(“DOLBY DIGITAL” lights up): The Dolby Digital signal processing is performed only when Dolby Digital signals are input.
 - * DTS mode(“ DTS” lights up): The DTS signal processing is performed only when DTS signals are input.
 - * MPEG mode(“MPEG” lights up): The MPEG signal processing is performed only when MPEG signals are input.
 - * PCM mode(“PCM” lights up): The PCM signal processing is performed only when PCM signals are input.

2

Select the desired surround mode.

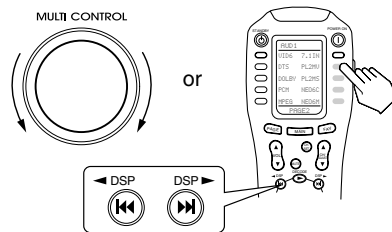

- Each time the MULTI CONTROL knob is rotated or the DSP MODE UP(▶) or DOWN(◀) button is pressed , the surround mode changes depending on the input signal format and the selected decoding mode as follows :

Signal format being input	Selected decoding mode	Selectable surround mode
Dolby Digital 5.1, Dolby Digital EX 6.1 channel sources Dolby Digital 2 channel sources	Auto, Dolby Digital mode	(DOLBY DIGITAL EX.) DOLBY DIGITAL (DOLBY DIGITAL EX.) DOLBY DIGITAL, PL II MOVIE, PL II MUSIC
DTS sources DTS 96/24 sources	Auto, DTS mode	(DTS ES MATRIX or DTS ES DISCRETE,) DTS DTS 96/24
MPEG sources	Auto, MPEG mode	MPEG
PCM (2 channel) sources Analog stereo sources	Auto, PCM mode —	PL II MOVIE, PL II MUSIC, BYPASS, DTS NEO 6 : CINEMA, DTS NEO 6 : MUSIC, THEATER, MOVIE, HALL 1/2, STADIUM, CHURCH, CLUB 1/2, ARENA 1/2, GAME, 4CH STEREO, MATRIX

(): Possible only when surround back channel is not set to “None”.(Refer to “When selecting the SPEAKER CONFIGURATION” on page 45.)

BYPASS mode: Audio signals bypass signal processing circuits for surround sound and are played in stereo mode.

If Dolby Pro Logic IIX, Dolby Virtual Speaker or Dolby Headphone mode is combined with BYPASS mode, you will enjoy its original surround effects, not affected by other surround modes.

- You can select the “PL II MOVIE”(or “PL IIX MOVIE”), “PL II MUSIC”(or “PL IIX MUSIC”), “DTS NEO: 6 CINEMA” or “DTS NEO : 6 MUSIC” mode directly on the remote control depending on the input signal format, the selected decoding mode and the surround back channel setting.
- When MPEG signals are input in the required decoding mode, the corresponding surround mode will be automatically selected regardless of using the MULTI CONTROL knob or DSP MODE UP(▶) or DOWN(◀) button.

■Notes:

- When the selected decoding mode is not matched to the input signal format, the indicator of the signal being input flickers, meaning the required process cannot be performed and no sound is heard. Therefore, be sure to select the required decoding mode and the available surround mode according to the input signal format.
- When the 8 CH DIRECT is selected as an input source, the decoding and surround modes cannot be selected.
- When the pure audio function is activated, the surround mode cannot be selected.
- When 96 kHz PCM signals are input, only the stereo mode can be selected.
- When DTS 96/24 or MPEG signals are input, the Dolby Pro Logic IIX, Dolby Virtual Speaker and Dolby Headphone modes cannot be selected.

■ When canceling the surround mode for normal stereo operation.

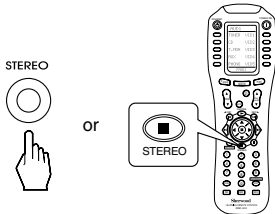

- Depending on the signal format which is being input, either the stereo mode or the 2CH downmix mode is selected.
- To cancel either the stereo mode or the 2 CH downmix mode, select the desired surround mode with using the MULTI CONTROL knob or DSP MODE UP/DOWN (▶/◀) buttons.

■ 2CH downmix mode

- This mode allows the multi-channel signals encoded in DTS, Dolby Digital or MPEG format to be mixed down into 2 front channels and to be reproduced through only two front speakers or through headphones.
- When the HEADPHONE SELECTOR button is set to the speaker off mode to listen with headphones, if the Dolby Headphone off mode is selected while playing the digital signals from DTS, Dolby Digital or MPEG sources, it will enter the 2CH downmix mode automatically.

To cancel the 2CH downmix mode, select the desired Dolby Headphone mode with pressing the DOLBY HEADPHONE button. (For details, refer to “To listen in a Dolby Headphone mode” on page 32.)

Listening in a Dolby Pro Logic Ix, Dolby Virtual Speaker or Dolby Headphone mode

■ To listen in a Dolby Pro Logic Ix mode

- Note : When the power amplifier for the surround back channels is assigned to the “ROOM2” or the surround back channel is set to “None”, the Dolby Pro Logic Ix mode cannot be selected.
- While listening in a surround mode, select the desired Dolby Pro Logic Ix mode.

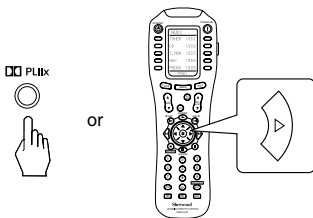

- Each time this button is pressed, the mode changes as follows:
→ PL IIX MOVIE → PL IIX MUSIC → Off(original surround mode)

- Combined with the original surround mode, Dolby Pro Logic Ix decoding creates 6.1 or 7.1 channel surround sound depending on whether the surround back channel is set to “1CH” or “2CH”.
- In case of playing in the stereo or 2CH downmix mode, it is canceled and the selected Dolby Pro Logic Ix mode will be combined with the previous surround mode.
- The desired mode can be selected with pressing the CURSOR RIGHT(▶) button only when the OSD menu operation is not performed.

■ To listen in a Dolby Virtual Speaker mode

- This mode creates a virtual surround sound field using as few as two front speakers, allowing you to experience listening from 5.1 channel speakers.

■ Note : Before using Dolby Virtual Speaker function, first set the speaker layout and virtualization mode as desired. (For details, “When selecting the VIRTUAL SPEAKER SETUP” on page 48.)

- While playing in a surround mode,

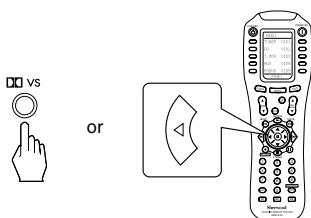

- “DOLBY VS ~” is displayed and combined with the original surround mode, this mode is activated.
- In case of playing in the stereo or 2CH downmix mode, it is canceled and the selected Dolby Virtual Speaker mode will be combined with the previous mode.
- To cancel the Dolby Virtual Speaker mode, press this button again. Then it returns to the previous mode.
- The desired mode can be selected with pressing the CURSOR LEFT (◀) button only when the OSD menu operation is not performed.

Continued

■ **To listen in a Dolby Headphone mode**

- The Dolby Headphone function simulates 5.1 channel surround sound, which allows you to enjoy 5.1 channel surround sound through 2 channel headphones, just like listening from 5.1 channel speakers.
- **Note :** Only when the HEADPHONE SELECTOR button is set to the speaker off mode, the Dolby Headphone mode can be selected.
- While listening with headphones, select the desired Dolby Headphone mode.

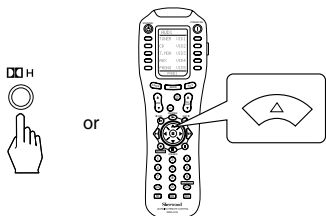

- Each time this button is pressed, the mode changes as follows :

- DOLBY HEADPHONE 1: This simulates the soundfield as if you were in a relatively small room with less reverberations.
- ↓
- DOLBY HEADPHONE 2: This simulates the soundfield as if you were in a typical listening room with moderate reverberations.
- ↓
- DOLBY HEADPHONE 3: This simulates the soundfield as if you were in a large space like theater.
- ↓
- Off : Depending on the signal format which is being input, either the stereo mode or the 2CH downmix mode is selected.

- Combined with the current mode, the selected Dolby Headphone mode is activated.
- The desired mode can be selected with pressing the CURSOR UP(▲) button only when the OSD menu operation is not performed.

■ **Notes :**

- In case of that the original surround mode is “DOLBY DIGITAL EX” or “DTS ES” mode, it will be automatically changed to “DOLBY DIGITAL” or “DTS” mode.
- Only when playing a stereo (2 channel) source in “PL IIX”, “DOLBY VS” or “DOLBY HEADPHONE” mode, you can select the original surround mode to be combined with use of the MULTI CONTROL knob or the DSP MODE UP(▶)/DOWN(◀) buttons.(However, in case of “PL IIX” mode, you cannot select “PL II”mode.)
- When “PL IIX” mode is selected while playing in “PL II” mode, it will be automatically changed to “DOLBY DIGITAL” or “BYPASS” mode depending on the signal format which is being input.

Selecting the desired surround speakers for different program sources

- When two sets of surround speakers are connected to the SURROUND A and B speaker terminals and are installed as described in “Speaker placement” on page 11, to achieve more effective surround sound depending on whether program source is movie or music and the different surround modes for the two types of sources, you can select the desired surround speakers.

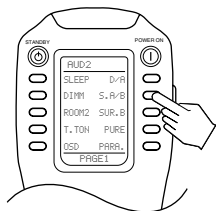

- Each time this button is pressed, the surround speakers are selected as follows :

- Surround A : When using surround speakers A for watching movies. (“A” lights up)
- ↓
- Surround B : When using surround speakers B for playing multi-channel music. (“B” lights up)
- ↓
- Surround A and B : When using both surround speakers A and B. (“A B” light up)

Selecting the surround back channel mode as connected

- You can set the surround back channel mode according to surround back speaker connection.

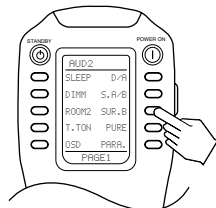

- Each time this button is pressed, the mode changes as follows :

- 1 channel : When a surround back speaker is connected. (“B” lights up)
- ↓
- 2 channel : When two surround back speakers are connected. (“B B” lights up)
- ↓
- None : When surround back speakers are not connected.

- **Note:** When the power amplifier for surround back channels is assigned to “ROOM2” or the surround speakers are all set to “None”, the surround back channel is automatically set to None.

Adjusting each channel level with test tone

• The volume level of each channel can be adjusted easily with the test tone function.

■Note: When speakers are switched off, the test tone function does not work.

1 Enter the test tone mode.

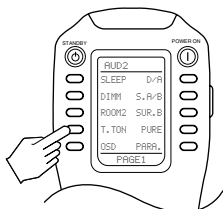

• The test tone will be heard from the speaker of each channel for 2 seconds as follows:

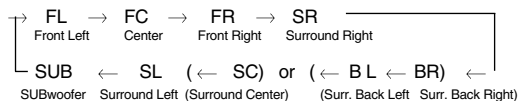

• Depending on the speaker setting (None or No), the test tone of the corresponding channel is not available.

• (): possible depending on whether the surround back channel is set to 2 CH or 1 CH.

2 At each channel, adjust the level as desired until the sound level of each speaker is heard to be equally loud.

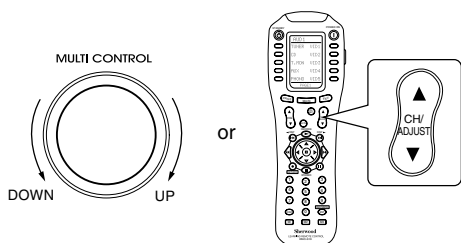

• You can select the desired channel and adjust its level with repeating the steps ① and ② in “Adjusting the current channel levels” procedure.

3 Cancel the test tone function.

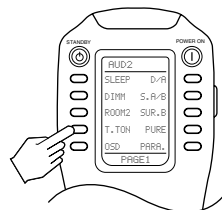

Adjusting the current channel levels

• After adjusting each channel level with test tone, adjust the channel levels either according to the program sources or to suit your tastes.

• If you have performed the CH LEVEL SETUP procedure on the OSD menu, you can memorize the adjusted channel levels into preset memory (PRESET 1, PRESET 2) and recall the memorized whenever you want. (Refer to “SETTING THE CH LEVEL SETUP” on page 63.)

1 Select the desired channel.

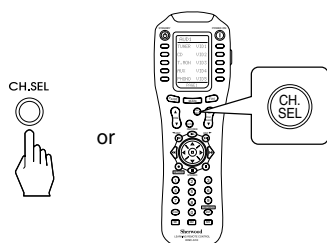

• Each time this button is pressed, the corresponding channel is selected as follows:

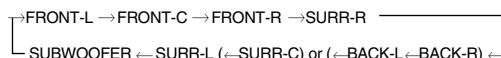

• Depending on the speaker settings and surround mode, etc., some channels cannot be selected.

• (): possible depending on whether the surround back channel is set to 2 CH or 1 CH.

■Note: When speakers are switched off, only FRONT-L and FRONT-R channels can be selected.

2 Adjust the level of the selected channel as desired.

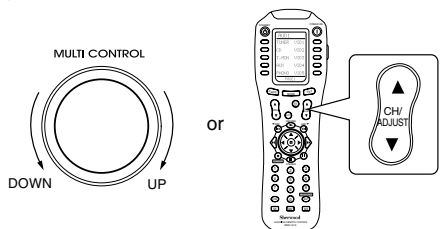

3 Repeat the above steps ① and ② to adjust each channel level.

Adjusting the Dolby Pro Logic IIx / Dolby Pro Logic II Music parameters

- When selecting either the Dolby Pro Logic IIx Music mode or the Dolby Pro Logic II Music mode depending on whether “S/B CH” is set to “None” or not, you can adjust the various surround parameters for optimum surround effect. (Refer to “When selecting the SPEAKER CONFIGURATION” on page 45.)
- In case of PL IIx MUSIC mode, only when original surround mode is “BYPASS” mode or 2 channel digital signals from Dolby Digital sources, etc. are input, these parameter settings affect the surround effects.

1 Press the DOLBY PL II MUSIC PARAMETER button to select the desired parameter.

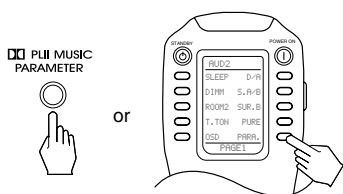

- Each time this button is pressed, the parameter changes and is displayed for several seconds as follows;

※ **Panorama mode (“PANORAMA”, default value : OFF)**

This mode extends the front stereo image to include the surround speakers for an exciting “wraparound” effect with side wall imaging. Select “OFF” or “ON”.

※ **Center width control (“C-WIDTH”, default value : 0)**

This adjusts the center image so it may be heard only from the center speaker, only from the left/right speakers as a phantom image, or from all three front speakers to varying degrees. The control can be set in 8 steps from 0 to 7.

※ **Dimension control (“DIMENSION”, default value : 0)**

This gradually adjusts the soundfield either towards the front or towards the rear. The control can be set in 7 steps from -3 to +3.

2 At the desired parameter, adjust it as desired.

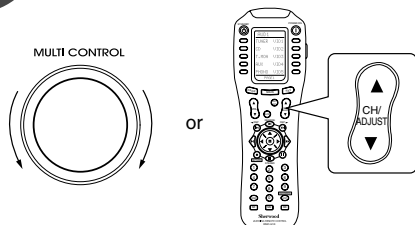

3 Repeat the above steps ① and ② to adjust other parameters.

- If the parameter display disappears, start from the step ① again.

LISTENING TO RADIO BROADCASTS

Auto tuning

1

Select the tuner.

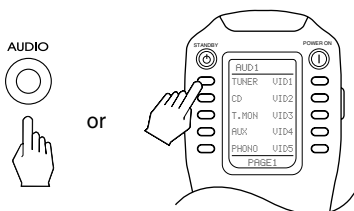

2

Select the desired band.

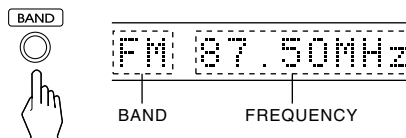

- Each time this button is pressed, the band is changed to FM or AM.
- When pressing the BAND button without selecting the TUNER, the tuner will be selected automatically.

3

Press the TUNING UP(+) or DOWN(-) button for more than 0.5 second.

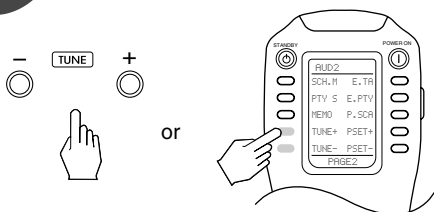

- Then "AUTO" appears on the display. The tuner will now search until a station of sufficient strength has been found. The display shows the tuned frequency and "TUNED".
- If the station found is not the desired one, simply repeat this operation.
- Weak stations are skipped during auto tuning.

Manual tuning

- Manual tuning is useful when you already know the frequency of the desired transmitter.
- Perform the steps ①~② in "Auto tuning" procedure and press the TUNING UP(+) or DOWN(-) button repeatedly until the right frequency has been reached.

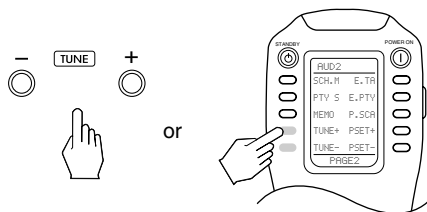

Auto presetting

- Auto presetting function automatically searches for FM stations only and store them in the memory.
- While listening to radio broadcasts, press and hold down the (ENTER)/MEMORY button for more than 3 seconds.

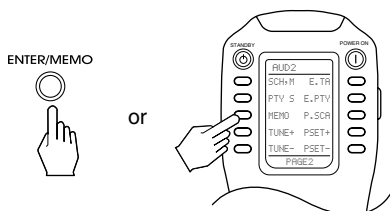

- Then "AUTO" lights up and this unit starts auto presetting.
- Up to 30 FM stations can be stored.
- Notes:
 - FM stations of weak strength cannot be memorized.
 - To memorize AM stations or weak stations, perform "Manual presetting" procedure with using "Manual tuning" operation.
 - When performing auto presetting with the remote control, first be sure to turn off the OSD menu display.

Manual presetting

- You can store up to 30 preferred stations in the memory.

1 Tune in the desired station with auto or manual tuning.

■ Note :

- When performing manual presetting with the remote control, first be sure to turn off the OSD manu display.

2 Press the (ENTER/) MEMORY button.

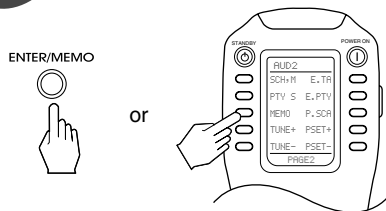

- “MEMORY” is flickering for several seconds.

3 Select the desired preset number (1~30) and press the (ENTER/)MEMORY button.

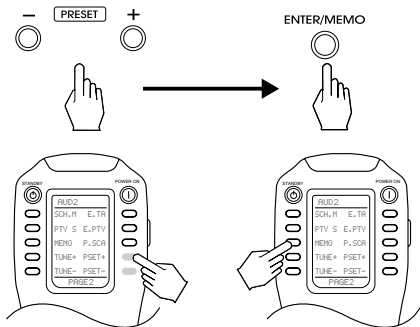

- When using the NUMERIC buttons on the remote control.

Examples) For “3” : ③
 For “15” : ① → within 2 seconds → ⑤
 For “30” : ⑩

- The station has now been stored in the memory.
- When using the NUMERIC buttons, the station is stored automatically without pressing the (ENTER/)MEMORY button.
- A stored frequency is erased from the memory by storing another frequency in its place.
- If “MEMORY” goes off, start again from the above step ②.

4 Repeat the above steps ① to ③ to memorize other stations.

■ MEMORY BACKUP FUNCTION

The following items, set before the receiver is turned off, are memorized.

- INPUT SELECTOR settings
- Surround mode settings
- Preset stations, etc.

Tuning to preset stations

- After selecting the tuner as input source, select the desired preset number.

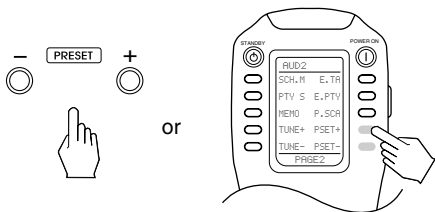

- When using the NUMERIC buttons on the remote control.

Examples) For “3” : ③
 For “15” : ① → within 2 seconds → ⑤
 For “30” : ⑩

Listening to FM stereo broadcasts

- While listening to FM broadcasts.
- Each time this button is pressed, the FM mode changes as follows;
 - Stereo mode : "STEREO" lights up.
 - ← Mono mode : "STEREO" goes off.
- When FM stereo broadcasts are poor because of weak broadcast signals, select the FM mono mode to reduce the noise, then FM broadcasts are reproduced in monaural sound.

FM MODE



Scanning preset stations in sequence

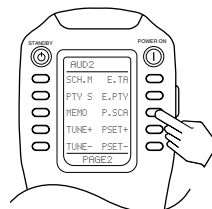

- The receiver will start scanning the stations in the preset sequence and each station is received for 5 seconds.
- At the desired station, press this button again to stop scanning.

RECORDING

- The analog signals from the 8 CH DIRECT inputs as well as the digital signals from DIGITAL inputs or USB can be heard but cannot be recorded.
- The volume, channel level, tone(bass, treble) settings, etc. have no effect on the recording signals.

Recording with TAPE MONITOR

- 1** Select the desired input as a recording source except TAPE MONITOR.

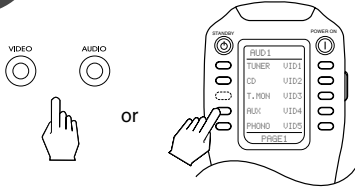

- You can select “VID 6” on the page 2 of “AUD 1” on the remote control.

- 2** Start recoding on the component connected to TAPE MONITOR.

- 3** Start play on the desired input.
- For tape monitor function, refer to “TAPE MONITOR function” on page 24.
 - When the AUX IN/OUT jacks are connected to audio recording component such as MD recorder, tape deck, etc., in the same manner, recording with AUX can be performed.

Dubbing from video components onto VIDEO 1

- 1** Select the desired input of VIDEO 2~ 6 as a recording source except VIDEO 1.

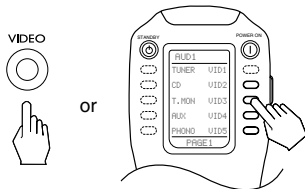

- You can select “VID 6” on the page 2 of “AUD 1” on the remote control.

- 2** Start recording on the component connected to VIDEO 1.

- 3** Start play on the desired input.
- The audio and video signals from the desired input will be dubbed onto the VIDEO 1 and you can enjoy them on the TV set and from the speakers.
 - When the VIDEO 2/(ROOM 2) IN/OUT jacks are connected to video recording component such as video deck, etc., in the same manner, recording with VIDEO 2 can be performed.
(If this is the case, be sure to deactivate the ROOM 2 function and to set the VIDEO 2 OUT to On. For details, refer to “When selecting the VIDEO 2 OUT” on page 57.)

Dubbing the sound and image signals separately onto VIDEO 1

Example) When dubbing the VIDEO 2 image signal and the CD sound signal separately onto VIDEO 1.

- 1** Select CD as an sound recording source.

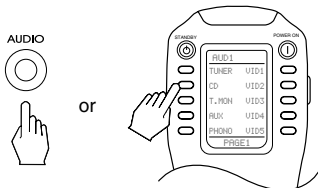

- 2** Select VIDEO 2 as a image recording source with performing “When selecting the CURRENT VIDEO” procedure on page 55.

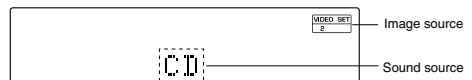

3

Start recording on the component connected to VIDEO 1.

4

Start play on the components connected to VIDEO 2 and CD respectively.

- The audio signal from the CD and the video signal from the VIDEO 2 will be dubbed and you can enjoy them on the TV set and from the speakers.
- When the VIDEO 2/(ROOM 2) IN/OUT jacks are connected to video recording component such as video deck, etc., in the same manner, recording with VIDEO 2 can be performed.

(If this is the case, be sure to deactivate the ROOM 2 function and to set the VIDEO 2 OUT to On. For details, refer to “When selecting the VIDEO 2 OUT” on page 57.)

DIGITAL AUDIO RECORDING WITH MD RECORDER

- Only when the OPTICAL or COAXIAL DIGITAL OUT of this receiver is connected to the OPTICAL or COAXIAL DIGITAL IN of the MD recorder or CD recorder, you can enjoy high-quality sound of digital recording without converting the original signals. Refer to “CONNECTING AUDIO COMPONENTS” and “CONNECTING DIGITAL INs and OUTs” on page 6 and 8 and the operating instructions of the MD recorder or CD recorder.
- However, when the COAXIAL DIGITAL OUT is connected to the component installed in another room for ROOM 2 playback, the digital signals from the COAXIAL DIGITAL OUT will be used for ROOM 2 playback.
- In this case that the COAXIAL DIGITAL OUT is connected to the MD recorder or CD recorder for digital recording, be sure to deactivate the ROOM 2 function.

■Notes:

- The digital signals being input into the USB terminal will not be output from the COAXIAL DIGITAL OUT.
- Digital recording is available for the digital audio program sources such as CDs, MDs, some DVDs, etc.
- In most DVDs as well as some CDs, etc., digital recording may not be available depending on the signal format.
- There are some restrictions on recording digital signals. When making digital recordings, refer to the operating instructions of your digital recording equipment to know what restrictions are imposed.

1

Select a desired input of CD, AUX and VIDEO 1~VIDEO 6 as a recording source.

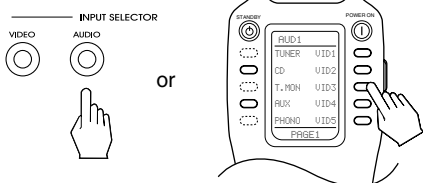

2

For digital recording, select the desired digital input as recording signal input.

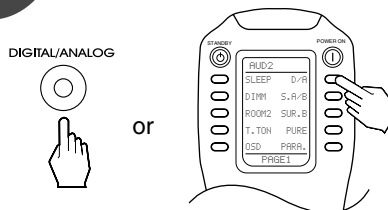

- Each time this button is pressed, the corresponding input is selected as follows:

→ DIGITAL → ANALOG →

- Note : When the selected digital input is not connected, “DIGITAL” is flickering, meaning no recording as well as no sound.

3

Start recording on the component connected to OPTICAL or COAXIAL DIGITAL OUT.

4

Start play on the desired input.

OTHER FUNCTIONS

Compressing the dynamic range (Dolby Digital sources only)

- This function compresses the dynamic range of previously specified parts of the Dolby Digital sound track (with extremely high volume) to minimize the difference in volume between the specified and non-specified parts.

This makes it easy to hear all of the sound track when watching movies at night at low levels.

1

While the digital signals from the Dolby Digital program source are being input.

DYNAMIC RANGE



- “DYNAMIC : ~” is displayed for several seconds.
- If the dynamic range mode disappears, start again from the above step ①.

2

Adjust the dynamic range as desired.

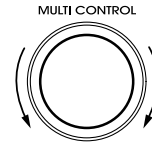

- Each time the MULTI CONTROL knob is rotated, the compression rate changes as follows:

0.0 ↔ 0.1 ↔ 0.2 ↔ ----- ↔ 0.9 ↔ 1.0
 Compression off ← lower higher →

- In some Dolby Digital software, this function may not be available.

Operating the sleep timer

- The sleep timer allows the system to continue to operate for a specified period of time before automatically shutting off.
- To set the receiver to automatically turn off after the specified period of time.

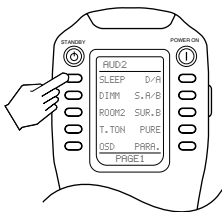

- Each time this button is pressed, the sleep time changes and disappears in several seconds as follows:

→ 10 → 20 → 30 → 60 → 90 → OFF
 Unit : minutes

- While operating the sleep timer, “Z” lights up.
- When the sleep time is selected, all display panels of Sherwood components connected by the DIGI LINK III are dimly lit.

Adjusting the brightness of the fluorescent displays

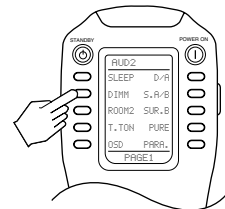

- Each time this button is pressed, the brightness of all fluorescent displays of Sherwood components connected by the DIGI LINK III changes together as follows:

→ ON → dim → OFF

- In the display OFF mode, pressing any button will restore the display ON mode.

Entering a label

- This function can be operated on the input sources except TUNER, TAPE MONITOR and 8 CH DIRECT.

- Select the desired input source to enter its label.

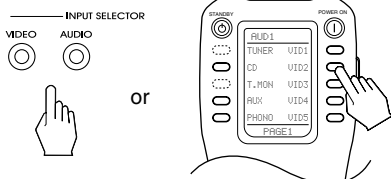

- You can select "VID 6" on the page 2 of "AUD 1" on the remote control.

- Select the character on the flickering digit.

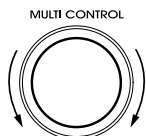

- Each time the MULTI CONTROL knob is rotated, the characters change as follows:

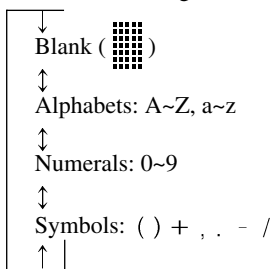

Correcting or clearing a label

- Select the desired input source to be rectified or cleared.

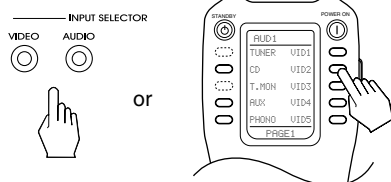

- You can select "VID 6" on the page 2 of "AUD 1" on the remote control.

- Press the LABEL button to enter the label input mode.
Example) When selecting VIDEO 1.



- Confirm your selection.



- Then the next digit will flicker.

- Repeat the above steps ③ and ④ to enter the desired characters on the rest of the digits.

- On up to 9 digits, the desired characters can be entered.
- Note: If any of INPUT SELECTOR buttons is pressed while entering a label, the label input mode will be canceled.

- Memorize the desired label.

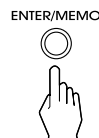

- Repeat the steps ②~⑥ in "Entering a label" procedure.

- To clear a label, make a blank on each digit and memorize it, then the label is cleared and its factory input source will be displayed.
- If the LABEL button is pressed for more than 3 seconds, blanks will be made on all the digits at once.

ROOM 2 SOURCE PLAYBACK

- This function allows enjoying one source in the main room and playing another in a different room at the same time.
- The analog signals from the 8 CH DIRECT inputs and TAPE MONITOR INs cannot be output from the (VIDEO 2/) ROOM 2 OUTs and the digital signals from the USB terminal cannot be output from the COAXIAL DIGITAL OUT, meaning no playback in a different room.
- When you connect the multi-room system kit to the IR IN jack of this receiver, you can control this receiver with not only the universal remote control unit but also the ROOM 2 remote control unit in a different room, too.
(For details, refer to "CONNECTING MULTI-ROOM SYSTEM KIT" on page 13 and "ROOM 2 Remote Controls" on page 23.)

■ **CAUTION** : Even when the ROOM 2 function is deactivated, if the VIDEO 2 OUT is set to On, the signals of the selected source as a main room source will be output from the VIDEO 2/ROOM 2 OUTs.(For details, refer to "When selecting the VIDEO 2 OUT" on page 57.)

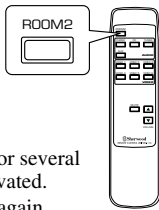
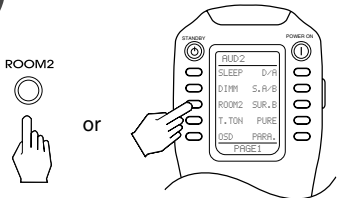
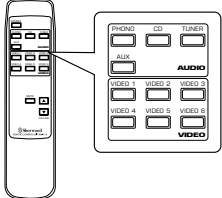
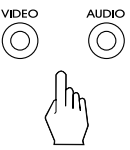
<p>■ When using the ROOM 2 remote control unit</p> <ul style="list-style-type: none"> • You can use the ROOM 2 function with the ROOM 2 remote control unit more conveniently. <p>1 Press the ROOM 2 button.</p>  <ul style="list-style-type: none"> • "R2" lights up and "(R2)~" is displayed for several seconds and the ROOM 2 function is activated. • To cancel the ROOM 2 function, press it again. Then "R2" goes off. • In the operating mode, when one of the ROOM 2 INPUT SELECTOR buttons on this remote control is pressed, the ROOM 2 function is automatically activated without pressing the ROOM 2 button and the desired input is selected. 	<p>■ When using the universal remote control unit or the buttons on the front panel.</p> <p>Press the ROOM 2 button.</p> <p>1</p>  <ul style="list-style-type: none"> • "R2" lights up and "(R2)~" is displayed for several seconds and the ROOM 2 function is activated. • To cancel the ROOM 2 function, press it again. Then "R2" goes off. • You can cancel the ROOM 2 function with using these buttons even in the standby mode.
<p>2 Select the desired input as a ROOM 2 source.</p>  <ul style="list-style-type: none"> • The selected ROOM 2 source is displayed for several seconds as follows: (R2) PHONO, (R2) TUNER, (R2) CD, (R2) AUX, (R2) VIDEO 1~6. • Only these sources can be played in another room. • When an audio program source is selected, as a ROOM 2 source, the image of the video program source selected previously can be played separately, too. (For details, refer to "SETTING THE ROOM2 FEED SETUP" on page 66.) • The MUTE and VOLUME UP/DOWN(▲/▼) buttons on this remote control can be available only when the ROOM 2 function is operating. <p>■ Note:</p> <ul style="list-style-type: none"> • When the muting effect for the ROOM 2 source is operating, "MUTE" is flickering. 	<p>2 Select the desired input as a ROOM 2 source while displaying "(R2)~".</p>  <ul style="list-style-type: none"> • The selected ROOM 2 source is displayed for several seconds. • Only while displaying "(R2)~", the volume level for the ROOM 2 source can be adjusted. • When "(R2)~" is not displayed, press the ROOM 2 button briefly twice.
<p>3 Start play on the component related to the ROOM 2 source.</p>	<p>3 Start play on the component related to the ROOM 2 source.</p>
<p>■ Notes:</p> <ul style="list-style-type: none"> • When the pure audio function is activated for the main room source, the video signals of the ROOM 2 source cannot be output, too. • Even when this receiver enters the standby mode, in such a case that "R2" lights up still and the STANDBY button lights up in blue as it does in the operating mode, meaning only the ROOM 2 circuitry operates, the ROOM 2 source can be played independently. • When the ROOM 2 function is operating in the standby mode, only the ROOM 2 remote control unit is available. • When you do not use the ROOM 2 function, cancel the ROOM 2 function to save electricity. • For ROOM 2 volume adjustment, refer to "SETTING THE ROOM 2 FEED SETUP" on page 66. 	

Using the OSD

This unit incorporates an OSD(On-screen display) function to provide information about basic operation of this unit and to simplify the setup procedures.

The OSD function uses a monitor TV connected to this unit as a display and has two kinds of display modes such as current status display and menu screen.

■Notes

- Any on-screen display shown on the monitor TV will not be recorded.
- Because this unit cannot support the OSD function for the progressively scanned video signal, the OSD for current status and menu settings may be displayed abnormally or may not be displayed.

CURRENT STATUS DISPLAY

This mode shows the status corresponding to each operation.

- The on-screen display will automatically disappear in several seconds.
- For examples, there are 2 status displays as follows.

■Notes :

- When watching a movie earnestly, if you want to turn off the current status display function, set the OSD auto display mode to Off. (For details, refer to "When selecting the OSD AUTO DISPLAY" on page 55.)

※ Current status display function might not operate as expected if :

- You view a movie via MONITOR COMPONENT OUTs while component video signals are input into this receiver.
- You view a movie via MONITOR COMPOSITE OUT while S-Video signals and composite video signals are input into this receiver.

■When selecting the desired input source.

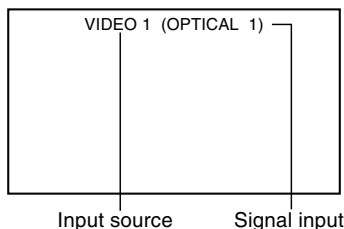

■When selecting the TEST TONE mode.

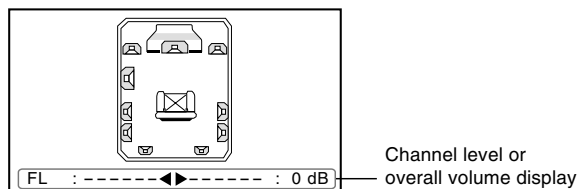

- When adjusting overall volume, the volume level display will be shown.
- The test tone display will be shown until the test tone mode is canceled.

OSD Menu Settings

- The OSD menu allows you to perform the setup procedures easily. In most situations, you will only need to set this once during the installation and layout of your home theater, and it rarely needs to be changed later. The OSD menu consists of 6 main menus: power amp assign, speaker setup, system setup, surround setup, CH level setup and room 2 feed setup. Some of these menus are divided into various sub-menus.
- The OSD menu settings are performed easily with the CURSOR control(▲, ▼, ◀, ▶), OSD, RETURN and ENTER buttons.

■Notes:

- In such a case of making only COMPONENT VIDEO connections between this receiver and video component, while viewing a movie via the MONITOR COMPONENT OUTs, if the OSD menu operation is performed, the picture is automatically turned off and only the OSD menu is displayed.
- When S-Video signals and composite video signals are input into this receiver, even though the OSD menu operation is performed, the OSD menu cannot be displayed via MONITOR COMPOSITE OUT.

1

Turn the menu screen on.

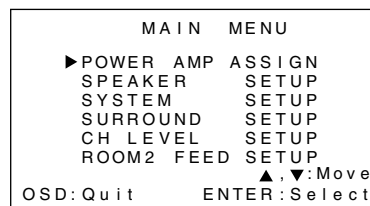
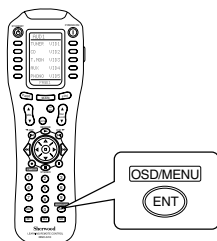

- The main menu will be shown.
- To turn the menu screen off, press this button again.

- In the bottom of the display, "OSD" stands for the OSD button, "RETURN" for "RETURN", "ENTER" for "ENTER", "▲", "▼", "◀" and "▶" for CURSOR UP(▲), DOWN(▼), LEFT(◀) and RIGHT(▶).

2 Select the desired menu using the CURSOR UP(▲)/DOWN(▼) buttons.

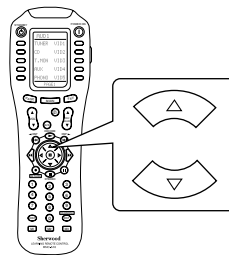

3 Confirm your selection.

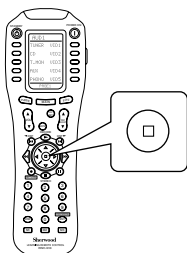

- The selected category or item will provide the needed setting details using the subsequent screens.

■ When selecting the POWER AMP ASSIGN

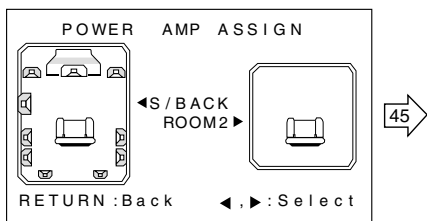

■ When selecting the SPEAKER SETUP

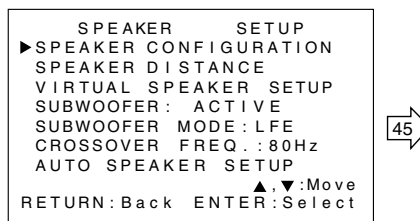

■ When selecting the SYSTEM SETUP

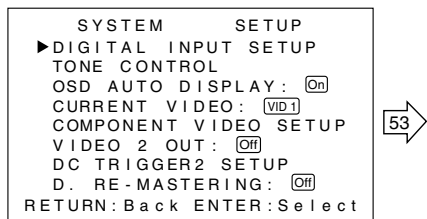

■ When selecting the SURROUND SETUP

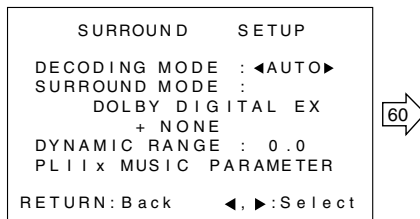

■ When selecting the CH LEVEL SETUP

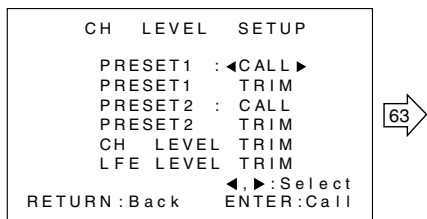

■ When selecting the ROOM2 FEED SETUP

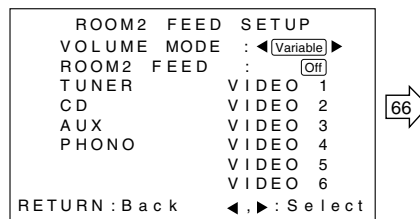

- For the setting details, see page in □.
- Adjust the setting(s) in each setting category to your preference.
- When the RETURN button is pressed on a sub-menu, the previous menu is resumed.

SETTING THE POWER AMP ASSIGN

- You can assign the power amplifier for the surround back channels to the ROOM 2. In this case, you need not use the power amplifier to drive the speakers additionally in a different room (ROOM 2).

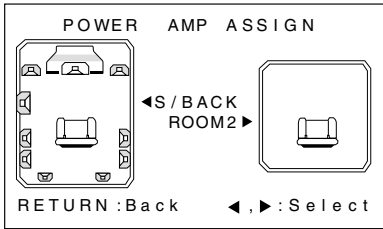

Press the CURSOR LEFT (◀)/RIGHT (▶) buttons to use the power amplifier as desired.

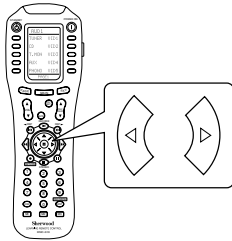

- Each time these buttons are pressed, the power amplifier is assigned as follows :

S /BACK : Select this to use power amplifier for the surround back channels.



ROOM 2 : Select this to use it for the ROOM 2.

SETTING THE SPEAKER SETUP

- After you have installed this unit and connected all the components, you first perform the speaker setup settings for the optimum sound acoustics according to your environment and speaker layout.
- Even when you change speakers, speaker positions, or the layout of your listening environment, you should perform the speaker setup settings, too.
- When performing the AUTO SPEAKER SETUP procedure, you need not perform the SPEAKER CONFIGURATION, SPEAKER DISTANCE and CH LEVEL SETUP procedures.

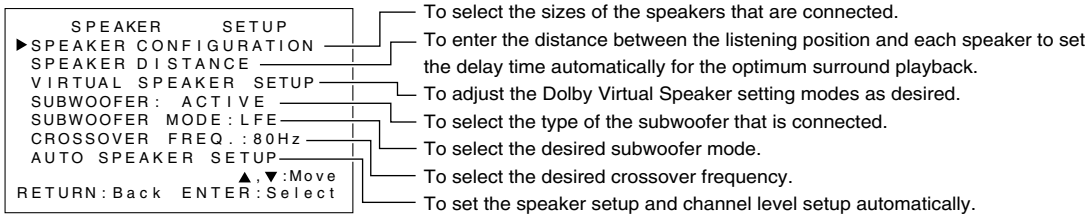

When selecting the SPEAKER CONFIGURATION

1

Press the CURSOR UP (▲)/DOWN (▼) buttons to select the SPEAKER CONFIGURATION, then press the ENTER button.

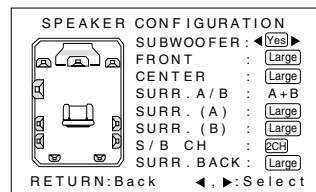
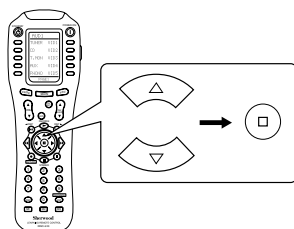

2

Press the CURSOR UP(▲)/DOWN(▼) buttons to select the desired speaker.

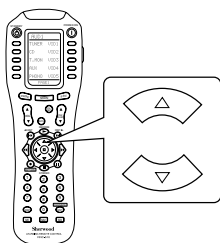

- Each time these buttons are pressed, “◀” and “▶” are moved to the corresponding speaker mode.

3

Press the CURSOR LEFT(◀)/RIGHT(▶) buttons to select the desired mode.

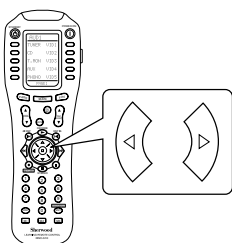

- Depending on your speaker type, you can select one of these following speaker types.
- Yes/No : Select the desired depending on whether a subwoofer is connected or not.
- Large : Select this when connecting speakers that can fully reproduce sounds below crossover frequency.
- Small : Select this when connecting speakers that cannot fully reproduce sounds below crossover frequency. When this is selected, sounds below crossover frequency are sent to the subwoofer.
- None : Select this when no speakers are connected. When this is selected, sounds are sent to the speakers which are not set to None.
- A/B/A+B : Select the desired depending on surround speaker connections (and whether program source is movie or music in such a case that two sets of surround speakers are connected).
- 2CH/1CH : Select the desired depending on the number of surround back speakers.

■ Notes :

- When speakers are set to “Small”, you should set the CROSSOVER FREQUENCY correctly according to their low frequency playback capacity. (Refer to “When selecting the CROSSOVER FREQUENCY” on page 50.)
- When “FRONT” is set to “Small”, “SUBWOOFER” is automatically set to “Yes”, and when “SUBWOOFER” is set to “No”, “FRONT” is automatically set to “Large”.
- When “FRONT” is set to “Small”, “CENTER”, “SURROUND” and “SURR. BACK” cannot be set to “Large”.
- When the power amplifier for surround back channels is assigned to “ROOM2” or the surround speakers are all set to None, “S/B CH” is automatically set to “None”.
- When “SURR. (A)” or “SURR. (B)” is set to “Small”, “SURR. BACK” cannot be set to “Large”.
- If either “SURR. (A)” or “SURR. (B)” is set to “Small”, the output is the same as when “SURR. (A)” and “SURR. (B)” are both set to “Small”.

4

Repeat the above steps ② and ③ until the speakers are all set to the desired mode.

When selecting the SPEAKER DISTANCE

1

Press the CURSOR UP(▲)/DOWN(▼) buttons to select the SPEAKER DISTANCE, then press the ENTER button.

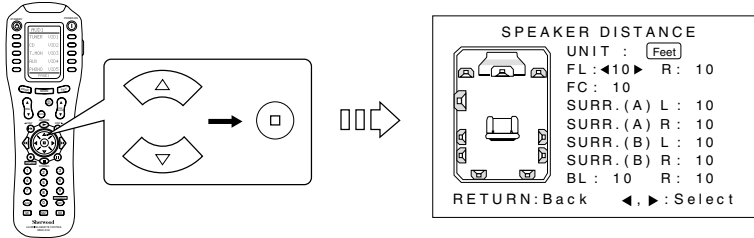

2

Press the CURSOR UP(▲)/DOWN(▼) buttons to select the unit.

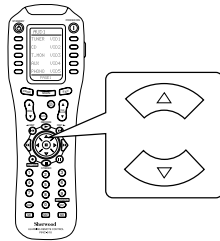

- Then “◀” and “▶” are moved to the unit mode.

3

Press the CURSOR LEFT(◀)/RIGHT(▶) buttons to select the desired unit.

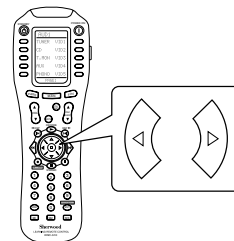

- Each time these buttons are pressed, “Meters” or “Feet” is selected.
- Once a unit is selected, the distances are automatically changed in the selected unit.

4

Press the CURSOR UP(▲)/DOWN(▼) buttons to select the desired speaker.

- Then “◀” and “▶” are moved to its distance.
- You cannot select the subwoofer and the speakers set to “None”.

5

Press the CURSOR LEFT(◀)/RIGHT(▶) buttons to enter the distance from the selected speaker to the listening position.

- You can set the distance within the range of 0.3~9 meters in 0.3 meter intervals(or 1~30 feet in 1 feet intervals)

6

Repeat the above steps ④ and ⑤ until the distances are all entered.

When selecting the VIRTUAL SPEAKER SETUP

1

Press the CURSOR UP(▲)/DOWN(▼) buttons to select the VIRTUAL SPEAKER SETUP, then press the ENTER button.

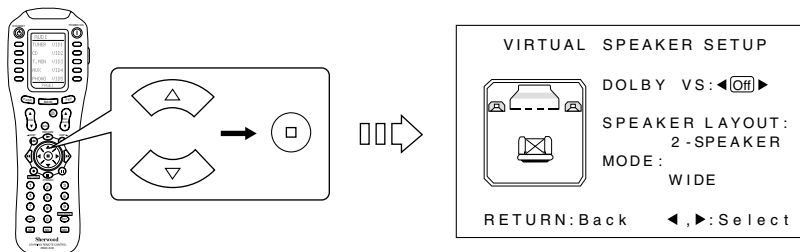

2

Press the CURSOR LEFT(◀)/RIGHT(▶) buttons to select the DOLBY VS(Virtual Speaker) mode as desired.

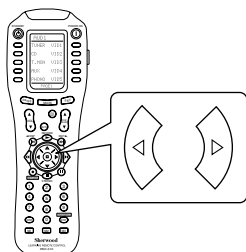

• Each time these buttons are pressed, the Dolby Virtual Speaker mode changes as follows :

On : Select this to activate the Dolby Virtual Speaker function.



Off : Select this to cancel it.

3

Press the CURSOR UP(▲)/DOWN(▼) buttons to select the SPEAKER LAYOUT mode.

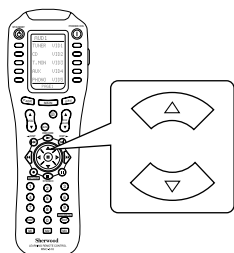

4

Press the CURSOR LEFT(◀)/RIGHT(▶) buttons to select the desired mode.

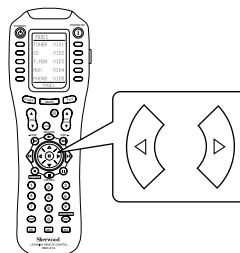

• You can select the desired one of four speaker layouts for actual speakers to be used .

• Each time these buttons are pressed , the speaker layout mode changes as follows :

2- SPEAKER : Select this when using 2 front speakers.



3- SPEAKER : Select this when using 2 front and center speakers.



4- SPEAKER : Select this when using 2 front and 2 surround speakers.



5- SPEAKER : Select this when using 2 front, center and 2 surround speakers.

■ Note :

• When the speakers are set to “None”, the corresponding speaker layout modes cannot be selected.

5

Press the CURSOR UP(▲)/DOWN(▼) buttons to select the virtualization mode.

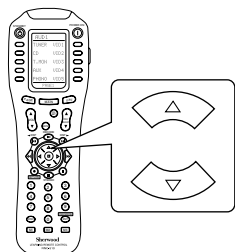

6

Press the CURSOR LEFT(◀)/RIGHT(▶) buttons to select the desired mode.

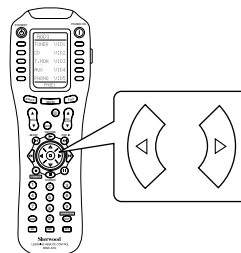

- Each time these buttons are pressed, the virtualization mode changes as follows:

WIDE: This mode expands the front channel sound field.



REFERENCE: This is the standard mode.

■Notes :

- When “WIDE” is selected as virtualization mode, you can select “2-SPEAKER”, “3-SPEAKER”, “4-SPEAKER” or “5-SPEAKER”.
- When “REFERENCE” is selected as virtualization mode, you can select “2-SPEAKER” or “3-SPEAKER” only.

When selecting the SUBWOOFER

- When the subwoofer without built-in amplifier is connected to “SURROUND BACK / SW” terminals, you should set “SUBWOOFER” to “PASSIVE”.

1

Press the CURSOR UP(▲)/DOWN(▼) buttons to select the SUBWOOFER.

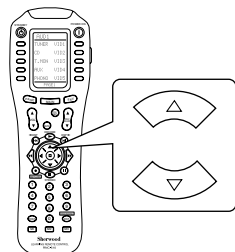

■Note :

- When “S/B CH” is set to “2 CH” on the SPEAKER CONFIGURATION menu, the SUBWOOFER cannot be selected.

2

Press the CURSOR LEFT(◀)/RIGHT(▶) buttons to select the desired mode.

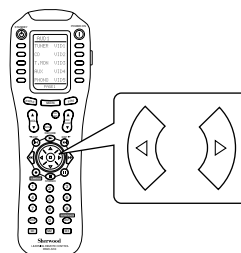

- Depending on your subwoofer type , you can select one of following types.

ACTIVE: Select this when connecting the powered subwoofer to “SW” of PREOUT jacks.

PASSIVE: Select this when connecting the subwoofer without built-in amplifier to “SURROUND BACK / SW” terminals.

■Note :

- If “SUBWOOFER” is set to “PASSIVE”, the SURROUND BACK RIGHT channel of the speaker terminals and the PREOUT jacks is automatically changed to SUBWOOFER channel.

When selecting the SUBWOOFER MODE

1

Press the CURSOR UP(▲)/DOWN(▼) buttons to select the SUBWOOFER MODE.

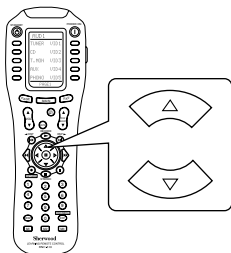

2

Press the CURSOR LEFT(◀)/RIGHT(▶) buttons to select the desired mode.

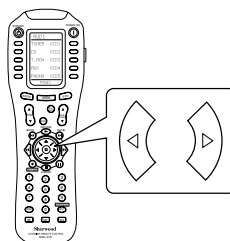

- Each time these buttons are pressed, the mode changes as follows :

LFE: Select this when the subwoofer reproduces only the low Frequency Effects from multi-channel sources that contain LFE channel, also called the “.1” channel.

LFE + SW: Select this when the subwoofer reproduces not only the Low Frequency Effects but also the bass sounds from stereo(2 channel) analog or PCM sources only.

- Regardless of subwoofer mode setting, the bass sounds of the speakers set to “Small” can be sent to the subwoofer.

When selecting the CROSSOVER FREQUENCY

1

Press the CURSOR UP(▲)/DOWN(▼) buttons to select the CROSSOVER FREQUENCY.

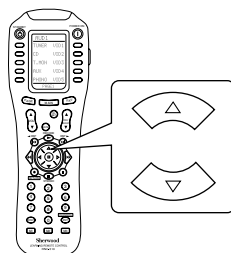

2

Press the CURSOR LEFT(◀)/RIGHT(▶) buttons to select the desired crossover frequency.

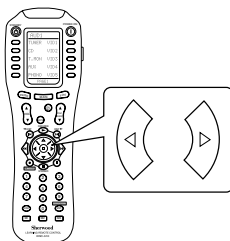

- You can select the desired within 40~120 Hz in 20 Hz intervals(default value: 80 Hz).
- For speakers set to “Small”, sound with a frequency below the selected crossover frequency is cut, and instead the cut bass sound is output from the subwoofer or speakers which are set to “Large”.
Example) When 100 Hz is selected , the bass sound below 100 Hz is output from the subwoofer or large front speakers(when not using a subwoofer).

When selecting the AUTO SPEAKER SETUP

- Auto Speaker Setup lets you avoid troublesome listening-based speaker setup and achieve good surround sound. You should connect the supplied microphone to the SETUP MIC jack so that this receiver can analyze the information from a series of test tones emitted from speakers and can adjust the size, distance and sound level of each speaker automatically.
- If you want to personalize your speaker setup and channel level setup by making the settings manually, perform the “When selecting the SPEAKER CONFIGURATION” procedure on page 45, “When selecting the SPEAKER DISTANCE” procedure on page 47, “Adjusting each channel level with test tone” and “Adjusting the current channel levels” procedures on page 33.

■ Preparations

1. Connect the supplied microphone to the SETUP MIC jack on the rear panel. (For details, refer to “CONNECTING MICROPHONE” on page 13.)

■ Note:

- After you have completed the auto speaker setup procedure, be sure to disconnect the microphone.
2. Place the microphone on a flat level surface at your normal listening position.
 - If possible, use a tripod, etc. to attach the microphone at the same height as your ears would be when you are seated in your listening position.
 - Ensure there are no obstacles between the speakers and the microphone.
 3. For the speakers to be set to “Small”, select the desired crossover frequency performing the “CROSSOVER FREQ.” procedure. (For details, refer to “When selecting the CROSSOVER FREQUENCY” on page 50.)

1

Press the CURSOR UP(▲)/DOWN(▼) buttons to select the AUTO SPEAKER SETUP, then press the ENTER button.

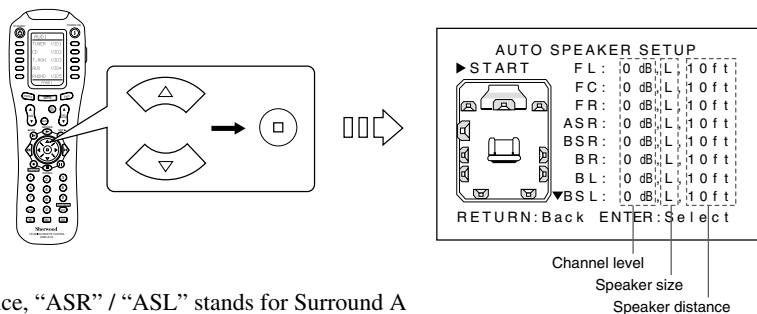

- For your reference, “ASR” / “ASL” stands for Surround A Right/Left and “BSR” / “BSL” for Surround B Right/Left.

2

Press the ENTER button to start the auto speaker setup procedure.

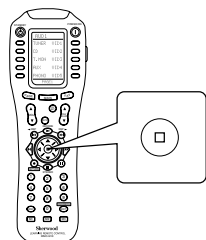

Result report

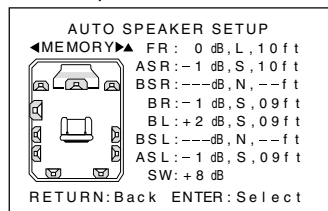

- Loud test tones are output from each speaker and then if auto speaker setup procedure has been completed, the results of each adjustment will be displayed.
- Each time the ENTER button is pressed, the auto speaker setup procedure will start or stop.
- If there may be a problem with speaker or microphone connection, error message will be displayed. In this case, turn off the power, check the connection as illustrated in error message and then retry the auto speaker setup procedure.

Continued

■Notes:

- For your reference, other channel levels displayed are the relative levels as compared with FL channel, not adjusted levels.
- Depending on “POWER AMP ASSIGN” and “SUBWOOFER” settings, etc., some channels may be excluded. (For details, refer to “SETTING THE POWER AMP ASSIGN” and “SETTING THE SPEAKER SETUP” on page 45.)
- Because the test tones are loud, ensure there no infants or small children in the room.
- For best results, ensure the room is as quiet as possible during the auto speaker setup procedure. If there is too much ambient noise, the results may not be satisfactory.
- If the results are not satisfactory, you can also personalize your speaker setup and channel level setup by making the settings manually. (For details, refer to “When selecting the SPEAKER CONFIGURATION” on page 45, “When selecting the SPEAKER DISTANCE” on page 47, “Adjusting each channel level with test tone” and “Adjusting the current channel levels” on page 33.)

3

To confirm the results, press the CURSOR LEFT(◀)/RIGHT(▶) buttons to select the “MEMORY”, then press the ENTER button.

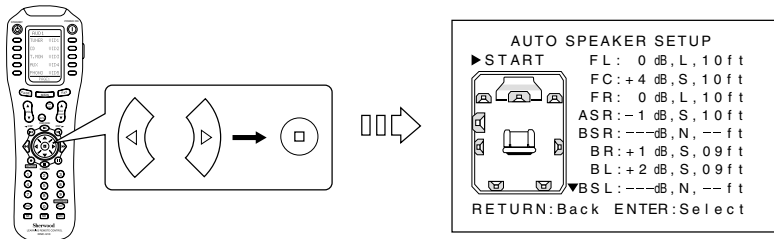

- Then the results are memorized.
- Each time the CURSOR LEFT(◀) or RIGHT(▶) button is pressed, the “MEMORY” or “START” is selected.
- However, if error message is displayed, the results cannot be memorized due to incorrect speaker connections, etc.. In this case, turn off the power, check the connections or change speakers as illustrated in error message and then retry the auto speaker setup procedure(, or memorize the result suggested in error message).

SETTING THE SYSTEM SETUP

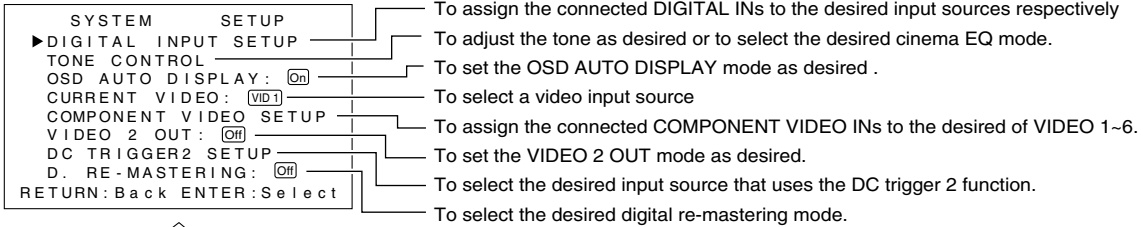

Note:

- When the pure audio function is activated, the TONE CONTROL cannot be selected.

When selecting the DIGITAL INPUT SETUP

- You should assign the connected DIGITAL INs to the desired of CD, AUX and VIDEO 1-6. (For details, refer to “CONNECTING DIGITAL INs and OUTs” on page 8.)

- 1** Press the CURSOR UP(▲)/DOWN(▼) buttons to select the DIGITAL INPUT SETUP, then press the ENTER button.

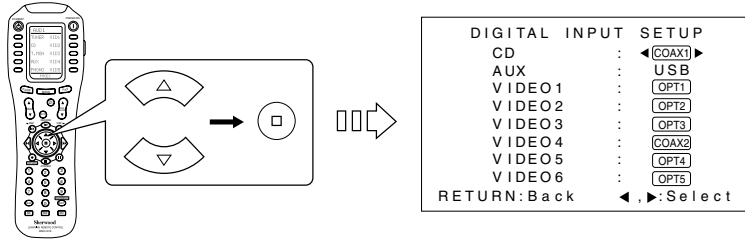

- 2** Press the CURSOR UP(▲)/DOWN(▼) buttons to select the desired input source.

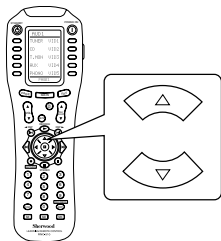

- Each time these buttons are pressed, “◀” and “▶” are moved to the corresponding DIGITAL IN.

- 3** Press the CURSOR LEFT(◀)/RIGHT(▶) buttons to select the desired DIGITAL IN.

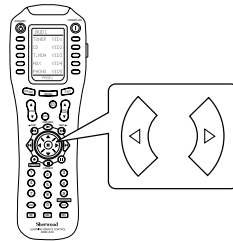

- Each time these buttons are pressed, the DIGITAL INs change.

Notes:

- When you select “None” instead of a DIGITAL IN for an input source, the analog input is automatically selected.
- In such a case that a DIGITAL IN is assigned to two input sources or more, when these input sources are selected, the digital audio signals can be heard from the same DIGITAL IN.

- 4** Repeat the above steps ② and ③ until the connected DIGITAL INs are assigned to the desired input sources respectively.

When selecting the TONE CONTROL

- 1** Press the CURSOR UP(▲)/DOWN(▼) buttons to select the TONE CONTROL, then press the ENTER button.

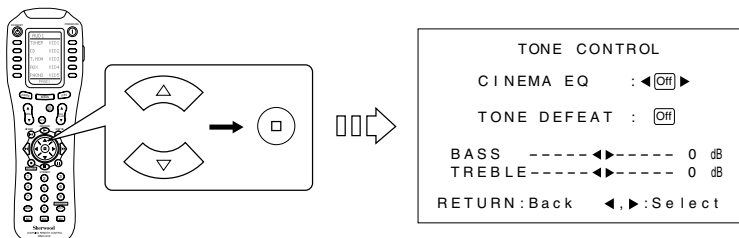

■Note:

- When the pure audio function is activated, the TONE CONTROL cannot be selected.

- 2** Press the CURSOR UP(▲)/DOWN(▼) buttons to select the desired item.

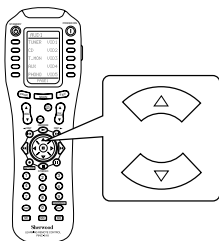

- Each time these buttons are pressed, “◀” and “▶” are moved to the corresponding mode.

- 3** Press the CURSOR LEFT(◀)/RIGHT(▶) buttons to select the desired mode.

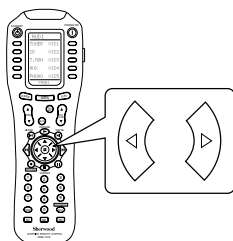

- Each time these buttons are pressed, the modes change as follows:

■When CINEMA EQ mode is selected

- When the pure audio function is activated, the cinema EQ function cannot be activated.

On : Select this to compensate for edgy or shrill movie sound tracks.



Off : Select this to cancel the cinema EQ function.

■When TONE DEFEAT mode is selected

On : Select this when listening to a program source without the tone effect.



Off : Select this when adjusting tone for your taste.

■Note :

- When the tone defeat mode is set to On, the tone (bass and treble) cannot be adjusted.

■When the tone defeat mode is set to Off to adjust the tone (bass and treble)

1. Press the CURSOR UP(▲)/DOWN(▼) buttons to select the desired tone mode.
2. At the desired tone mode, press the CURSOR LEFT(◀)/RIGHT(▶) buttons to adjust the selected tone as desired.
 - The tone level can be adjusted within the range of -10 ~+10 dB.
 - In general, we recommend the bass and treble to be adjusted to 0 dB(flat level).
 - Extreme settings at high volume may damage your speakers.
3. To complete tone adjustment, repeat the above steps 1 and 2.

When selecting the OSD AUTO DISPLAY

- When the OSD AUTO DISPLAY is set to On, the current status display overlaps the program image on the monitor TV and may interfere with your movie enjoyment. In such a case, set the OSD AUTO DISPLAY to Off.

- 1 Press the CURSOR UP(▲)/DOWN(▼) buttons to select the OSD AUTO DISPLAY.

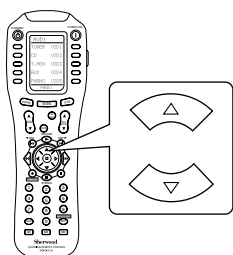

- 2 Press the CURSOR LEFT(◀)/RIGHT(▶) buttons to select the desired mode.

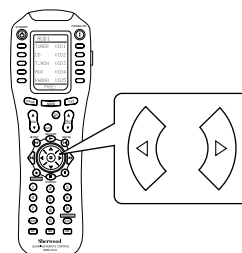

- Each time these buttons are pressed, the mode changes as follows:

- On : To turn on the current status display.
- ↕
- Off : To turn off the current status display.

When selecting the CURRENT VIDEO

- You can select a video input source on the OSD menu and enjoy its image.

- 1 Press the CURSOR UP(▲)/DOWN(▼) buttons to select the CURRENT VIDEO.

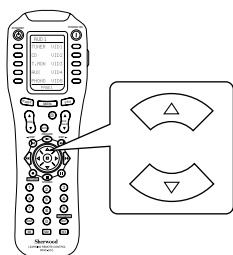

- 2 Press the CURSOR LEFT(◀)/RIGHT(▶) buttons to select the desired video input source.

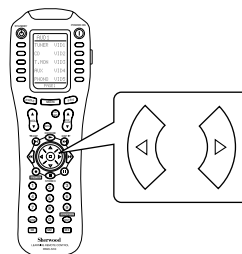

- Each time these buttons are pressed, the video input source changes.

When selecting the COMPONENT VIDEO SETUP

- You should assign the connected COMPONENT VIDEO INs to the desired of VIDEO 1-6.
(For details, refer to “CONNECTING VIDEO COMPONENTS” on page 6-7.)

- 1** Press the CURSOR UP(▲)/DOWN(▼) buttons to select the COMPONENT VIDEO SETUP, then press the ENTER button.

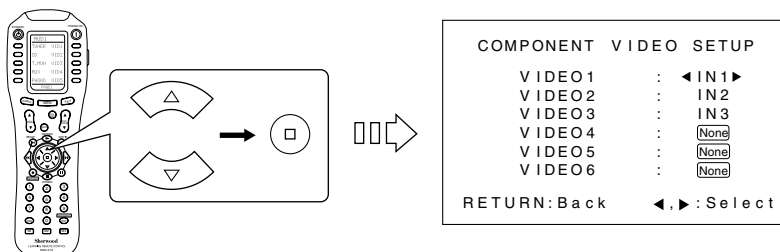

- 2** Press the CURSOR UP(▲)/DOWN(▼) buttons to select the desired input source.

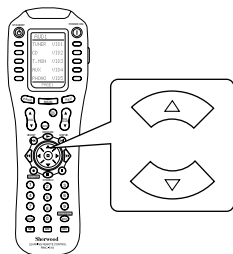

- Each time these buttons are pressed, “◀” and “▶” are moved to the corresponding COMPONENT VIDEO IN.

- 3** Press the CURSOR LEFT(◀)/RIGHT(▶) buttons to select the desired COMPONENT VIDEO IN.

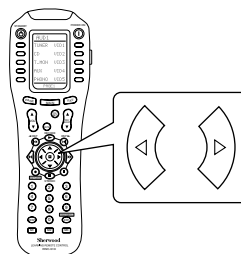

- Each time these buttons are pressed, the COMPONENT VIDEO INs change.

■ Note :

- In such a case that a COMPONENT VIDEO IN is assigned to two input sources or more, when these input sources are selected, the component video signals can be viewed from the same COMPONENT VIDEO IN.

- 4** Repeat the above steps ② and ③ until the connected COMPONENT VIDEO INs are assigned to the desired input sources respectively.

When selecting the VIDEO 2 OUT

- When performing recording with the video recording component connected to VIDEO 2 (/ROOM 2) IN/OUT jacks, you should set the VIDEO 2 OUT to On and deactivate the ROOM 2 function.

■Note: When the ROOM 2 function is activated, ROOM 2 source playback will be performed regardless of the VIDEO 2 OUT setting.

- Press the CURSOR UP(▲)/DOWN(▼) buttons to select the VIDEO 2 OUT.

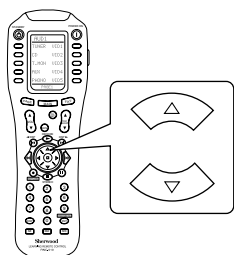

- Press the CURSOR LEFT(◀)/RIGHT(▶) buttons to select the desired mode.

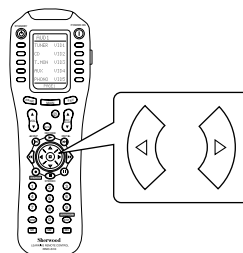

- Each time these buttons are pressed, the mode changes as follows:
 - On : Select this to output the signals of the selected source as a recording (main room) source from the VIDEO 2/ROOM 2 OUTs.
 - Off : Select this not to output the signals.

When selecting the DC TRIGGER 2 SETUP

- To turn on the component connected to DC TRIGGER OUT 2 jack when the desired input source is selected, you should link DC TRIGGER 2 with the desired input source.

- Press the CURSOR UP(▲)/DOWN(▼) buttons to select the DC TRIGGER 2, then press the ENTER button.

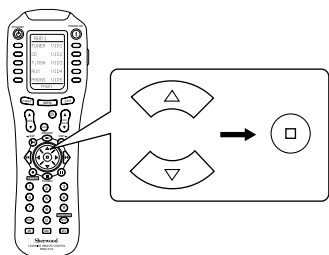

```

DC TRIGGER2 SETUP
DC TRIGGER : ◀Off▶
TUNER      VIDEO 1
CD         VIDEO 2
AUX        VIDEO 3
TAPE MON. VIDEO 4
PHONO     VIDEO 5
           VIDEO 6
ENTER : Set  ▲, ▼, ◀, ▶ : Move
    
```

- Press the CURSOR LEFT(◀)/RIGHT(▶) buttons to select the DC TRIGGER 2 mode as desired.

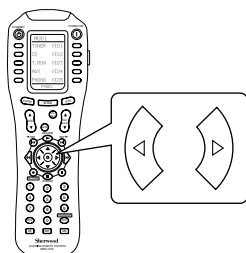

- Each time these buttons are pressed, the DC TRIGGER 2 mode changes as follows:
 - On : Select this to activate the DC trigger function.
 - Off : Select this to cancel the DC trigger function.

■ When the DC TRIGGER 2 mode is set to On

3 Press the CURSOR UP(▲)/DOWN(▼)/LEFT(◀)/RIGHT(▶) buttons to select the desired input source that uses the DC trigger 2 function, then press the ENTER button.

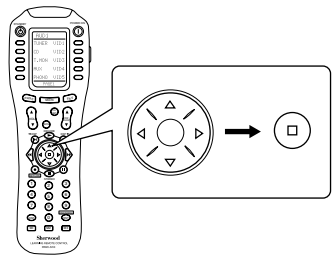

- Each time the CURSOR CONTROL buttons are pressed, “▶” is moved to the corresponding input source.
- When the ENTER button is pressed at the desired input source, “+” is marked it with.
- When the input sources marked with “+” on this menu are selected with the AUDIO and VIDEO SELECTOR buttons, etc., the DC trigger function is automatically activated. (For details, refer to “CONNECTING DC TRIGGER OUTs” on page 12.)
- When the ENTER button is pressed at the input source marked with “+”, “+” is cleared and the DC trigger 2 function is canceled for this input source.
- Repeat this step until the desired input sources are all selected.

When selecting the DIGITAL RE-MASTERING

1 Press the CURSOR UP(▲)/DOWN(▼) buttons to select the DIGITAL RE-MASTERING.

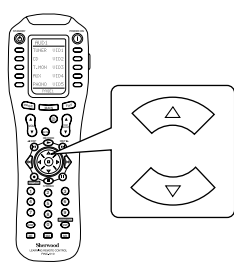

2 Press the CURSOR LEFT(◀)/RIGHT(▶) buttons to select the desired mode.

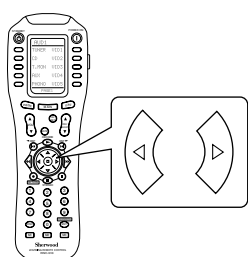

- Each time these buttons are pressed, the digital re-mastering mode changes as follows:
 On : Select this to process the input signal digitally and to convert its sampling frequency to 192 kHz for an more detailed sound reproduction.
 ⇕
 Off : Select this to cancel the digital re-mastering function.

■ Notes :

- The digital re-mastering function does affect on the front left and right signals only. However, it does not affect on the digital signals that are output from the DIGITAL OUTs of this unit.
- When the stereo mode or the pure audio function is selected while playing analog stereo sources, the digital re-mastering function cannot be activated.

When selecting the A/V SYNC

- There may be a slight delay between the video and audio signals in case that some video playback equipments may process the video signals later than the audio signals due to signal processing procedure, etc.. Should this happen, you can adjust the A/V SYNC to synchronize sound with image.

1

Press the CURSOR UP(▲)/DOWN(▼) buttons to select the A/V SYNC.

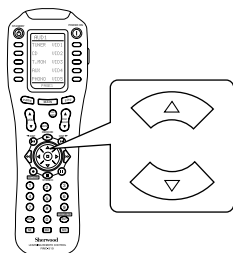
**2**

Press the CURSOR LEFT(◀)/RIGHT(▶) buttons to adjust the A/V SYNC as desired.

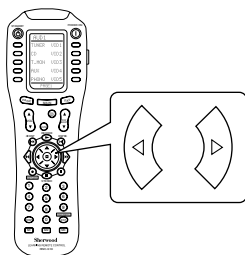

- Each time these buttons are pressed, the A/V SYNC can be adjusted within the range of 0~6 frame.

SETTING THE SURROUND SETUP

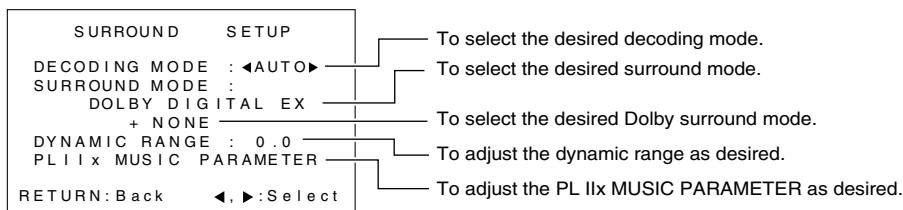

■Notes :

- Only when the digital input is selected as signal input, the decoding mode and the surround mode can be both selected as desired.
- When the analog input is selected, only the surround mode can be selected as desired.
- When the 8 CH DIRECT is selected as an input source, you cannot perform the surround setup.

When selecting the DECODING MODE, SURROUND MODE, DYNAMIC RANGE

1

Press the CURSOR UP(▲)/DOWN(▼) buttons to select the desired item.

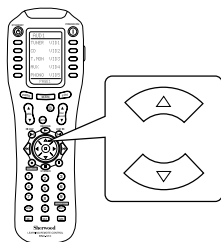

- Each time these buttons are pressed, “◀” and “▶” are moved to the corresponding mode.

2

Press the CURSOR LEFT(◀)/RIGHT(▶) buttons to select the desired mode.

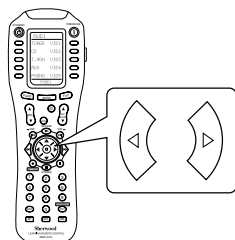

- Each time these buttons are pressed, the modes change as follows according to the selected item :

■When DECODING MODE is selected

- Depending on the input digital signal format, you can select the desired decoding mode.
 - AUTO : Select this for automatic detection of a digital input signal format.
The input digital signal format (DTS, Dolby Digital, MPEG or PCM(2 channel stereo), etc.) used by the selected digital input source is detected automatically to perform the necessary decoding process for optimum surround modes.
 - DOLBY DIGITAL : Select this for Dolby Digital signal processing. The decoding process is performed only when Dolby Digital signals are input.
 - DTS : Select this for DTS signal processing. The decoding process is performed only when DTS signals are input.
 - MPEG : Select this for MPEG signal processing. The decoding process is performed only when MPEG signals are input.
 - PCM : Select this for PCM signal processing. The decoding process is performed only when PCM signals are input.

■Notes :

- Surround sound effect will not work properly if the signal passes through a graphic equalizer.
Please refer to your equalizer operating instructions for guidance on switching off(or defeating) the equalizer.
- Only when the digital input is selected as signal input for the input sources except PHONO, TUNER and TAPE MONITOR, the decoding mode can be selected.
- Noise may be generated at the beginning of playback and while searching during DTS playback in the auto mode. In this case, try playing in the DTS mode.

■ When the SURROUND MODE is selected

- Depending on the input signal format and the selected decoding mode, you can select the desired surround mode as follows:

Signal format being input	Selected decoding mode	Selectable surround mode
Dolby Digital 5.1, Dolby Digital EX 6.1 channel sources	Auto, Dolby Digital mode	(DOLBY DIGITAL EX,) DOLBY DIGITAL
Dolby Digital 2 channel sources		(DOLBY DIGITAL EX,) DOLBY DIGITAL, PL II MOVIE, PL II MUSIC
DTS sources	Auto, DTS mode	(DTS ES MATRIX or DTS ES DISCRETE,) DTS
DTS 96/24 sources		DTS 96/24
MPEG sources	Auto, MPEG mode	MPEG
PCM (2 channel) sources	Auto, PCM mode	PL II MOVIE, PL II MUSIC, BYPASS, DTS NEO 6 : CINEMA, DTS NEO 6 : MUSIC, THEATER, MOVIE, HALL 1/2, STADIUM, CHURCH, CLUB 1/2, ARENA 1/2, GAME, 4CH STEREO, MATRIX
Analog stereo sources	—	

() : Possible only when surround back channel is not set to "None".(Refer to "When selecting the SPEAKER CONFIGURATION" on page 45.)

BYPASS mode: Audio signals bypass signal processing circuits for surround sound and are played in stereo mode.

If Dolby Pro Logic Iix, Dolby Virtual Speaker or Dolby Headphone mode is combined with BYPASS mode, you will enjoy its original surround effects, not affected by other surround modes.

■ Notes:

- When the selected decoding mode is not matched to the input signal format, the indicator of the signal being input flickers, meaning the required process cannot be performed and no sound is heard. Therefore, be sure to select the required decoding mode and the available surround mode according to the input signal format.
- When the pure audio function is activated, the surround mode cannot be selected.
- When 96 kHz PCM signals are input, only the stereo mode can be selected.
- When DTS 96/24 or MPEG signals are input, the Dolby Pro Logic Iix, Dolby Virtual Speaker and Dolby Headphone modes cannot be selected.

■ When thez Dolby surround mode is selected

* In case that the HEADPHONE SELECTOR button is set to speaker on mode.

- Combined with the original surround mode, the Dolby surround mode can be selected as follows:

→ (PL Iix MOVIE ↔ PL Iix MUSIC ↔) DOLBY VS~ ↔ NONE(Dolby surround off) ←
(original surround mode)

() : Impossible only when the power amplifier for the surround back channels is assigned to the "ROOM2" or surround back channel is set to "None".

- In case of playing in the stereo or 2CH downmix mode, it is canceled and the selected "PL Iix" or "DOLBY VS" mode will be combined with the previous mode.

* In case that the HEADPHONE SELECTOR button is set to speaker off mode.

- Combined with the current mode, the Dolby Headphone mode can be selected as follows:

→ DOLBY HEADPHONE 1 ↔ DOLBY HEADPHONE 2 ↔ DOLBY HEADPHONE 3 ↔ NONE(Dolby Headphone off) ←

- If you select the Dolby Headphone off mode, either the stereo mode or the 2 CH downmix mode will be selected depending on the signal format which is being input.

■ Notes :

- In case of that the original surround mode is "DOLBY DIGITAL EX" or "DTS ES" mode, it will be automatically changed to "DOLBY DIGITAL" or "DTS" mode.
- Only when playing a stereo(2 channel) source in "PL Iix", "DOLBY VS" or "DOLBY HEADPHONE" mode, you can select the original surround mode to be combined.(However, in case of "PL Iix" mode, you cannot select "PL II" mode.)
- When "PL Iix" mode is selected while playing in "PL II" mode, it will be automatically changed to "DOLBY DIGITAL" or "BYPASS" mode depending on the signal format which is being input.

■ When the DYNAMIC RANGE is selected

- This function compresses the dynamic range of previously specified parts of the Dolby Digital sound track (with extremely high volume) to minimize the difference in volume between the specified and non-specified parts.

This makes it easy to hear all of the sound track when watching movies at night at low levels.

- The compression rate changes as follows :

0.0 ↔ 0.1 ↔ 0.2 ↔ ----- ↔ 0.9 ↔ 1.0
Compression off ← lower higher →

■ Notes :

- Only while the digital signals from the Dolby Digital program source are being input, the dynamic range function can be activated.
- In some Dolby Digital software, this function may not be available.

When selecting the PL IIx MUSIC PARAMETER(or the PL II MUSIC PARAMETER)

■ Notes:

- Depending on whether “S/B CH” is set to “None” or not, you can select either the Dolby Pro Logic II surround or the Dolby Pro Logic IIx surround and can adjust its parameters as desired only while listening in either the PL II MUSIC mode or the PL IIx MUSIC mode.
(Refer to “When selecting the SPEAKER CONFIGURATION” on page 45.)
- In case of PL IIx MUSIC mode, only when original surround mode is “BYPASS” mode or 2 channel digital signals from Dolby Digital sources, etc. are input, these parameter settings affect the surround effects.

1 Press the CURSOR UP(▲)/DOWN(▼) buttons to select the PL II(x) MUSIC PARAMETER, then press the ENTER button.

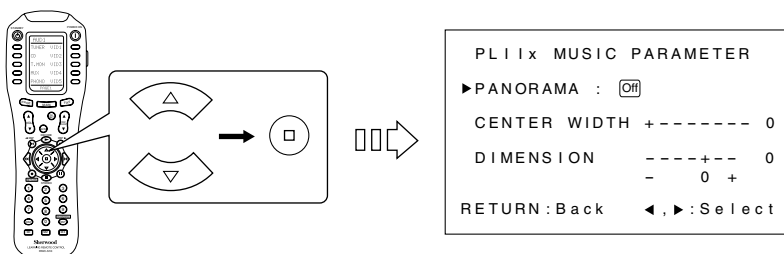

2 Press the CURSOR UP(▲)/DOWN(▼) buttons to select the desired parameter.

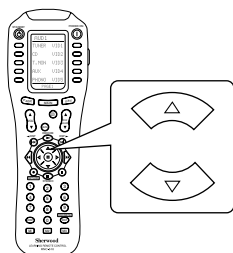

3 Press the CURSOR LEFT(◀)/RIGHT(▶) buttons to adjust the selected parameter as desired.

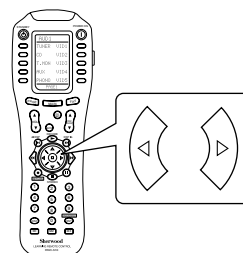

■ When selecting the PANORAMA mode

This mode extends the front stereo image to include the surround speakers for an exciting “wraparound” effect with side wall imaging. Select “Off” or “On”(default value:Off).

■ When selecting the CENTER WIDTH control

This adjusts the center image so it may be heard only from the center speaker, only from the left/right speakers as a phantom image, or from all three front speakers to varying degrees.

The control can be set in 8 steps from 0 to 7(default value : 0).

■ When selecting the DIMENSION control

This gradually adjusts the soundfield either towards the front or towards the rear. The control can be set in 7 steps from -3 to +3(default value : 0).

4 Repeat the above steps ② and ③ to adjust other parameters.

SETTING THE CH LEVEL SETUP

CH LEVEL SETUP		
PRESET 1 : ◀CALL ▶	←	To recall the channel levels memorized into preset memory or to memorize the channel levels adjusted in the CH LEVEL TRIM menu, etc.
PRESET 1 TRIM	→	To memorize the adjusted channel levels into preset memory.
PRESET 2 : CALL	←	
PRESET 2 TRIM	→	
CH LEVEL TRIM	←	To adjust the current channel levels as desired.
LFE LEVEL TRIM	←	To adjust LFE (Low Frequency Effect) levels included in Dolby Digital, DTS and MPEG program sources.
RETURN : Back	◀ ▶ : Select	
	ENTER : Call	

When selecting the PRESET 1 or PRESET 2

- You can recall the memorized channel levels whenever you want or can memorize the channel levels adjusted in the CH LEVEL TRIM menu, etc. into preset memory.

- Press the CURSOR UP(▲)/DOWN(▼) buttons to select the PRESET 1 or PRESET 2 .

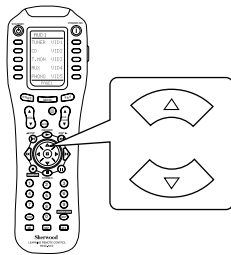

- Press the CURSOR LEFT(◀)/RIGHT(▶) buttons to select the desired mode, then press the ENTER button.

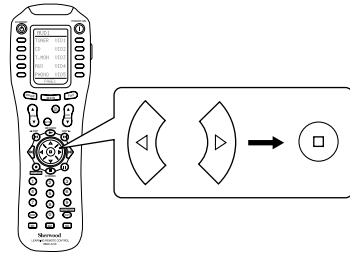

- Each time these buttons are pressed , the mode changes as follows :

CALL : Select this to recall the channel levels memorized into preset memory .



SAVE : Select this to memorize the channel levels adjusted in the CH LEVEL TRIM menu or in “Adjusting the current channel levels” procedure on page 33.

When selecting the PRESET 1 TRIM or PRESET 2 TRIM

- You can adjust the channel levels directly in the PRESET TRIM menu and can memorize them into preset memory.

- Press the CURSOR UP(▲)/DOWN(▼) buttons to select the PRESET 1TRIM or PRESET 2 TRIM, then press the ENTER button.

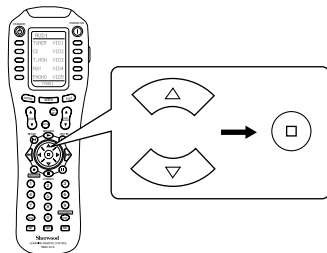

Example) When the PRESET 2 TRIM is selected .

PRESET 2	TRIM	
▶FL	-----▶	0 dB
FC	-----▶	0 dB
FR	-----▶	0 dB
SR	-----▶	0 dB
BR	-----▶	0 dB
BL	-----▶	0 dB
SL	-----▶	0 dB
SW	-----▶	0 dB
RETURN	: Back	◀, ▶: Select

2 Press the CURSOR UP(▲)/DOWN(▼) buttons to select the desired channel.

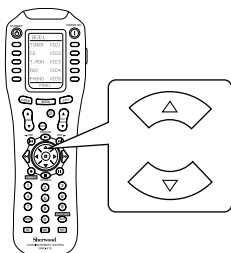

- Each time these buttons are pressed, “▶” is moved to the corresponding channel.

■Note :

- Depending on the speaker settings and surround mode, etc., some channels cannot be selected.

3 Press the CURSOR LEFT(◀)/RIGHT(▶) buttons to adjust the level of the selected channel as desired.

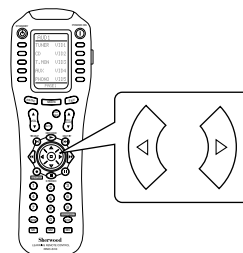

- Each time these buttons are pressed, the channel level can be adjusted within the range of -15~+15 dB.

4 Repeat the above steps ② and ③ to adjust each channel level until the sound level of each speaker is heard to be equally loud.

When selecting the CHANNEL LEVEL TRIM

- You can adjust the current channel levels as desired. These adjusted levels are just memorized, not into preset memory.

1 Press the CURSOR UP(▲)/DOWN(▼) buttons to select the CH LEVEL TRIM, then press the ENTER button.

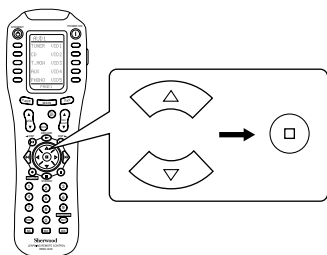

CH LEVEL TRIM		
▶FL	: - - - - -▶	: 0 dB
▶FC	: - - - - -▶	: 0 dB
FR	: - - - - -▶	: 0 dB
SR	: - - - - -▶	: 0 dB
BR	: - - - - -▶	: 0 dB
BL	: - - - - -▶	: 0 dB
SL	: - - - - -▶	: 0 dB
SW	: - - - - -▶	: 0 dB
RETURN	: Back	◀, ▶: Select

2 Perform the steps ②~④ in “When selecting the PRESET 1 TRIM or PRESET 2 TRIM” procedure on the previous page.

- You can memorize the current channel levels into preset memory with performing “When selecting the PRESET 1 or PRESET 2 ” procedure on the previous page.

When selecting the LFE LEVEL TRIM

1

Press the CURSOR UP(▲)/DOWN(▼) buttons to select the LFE LEVEL TRIM, then press the ENTER button.

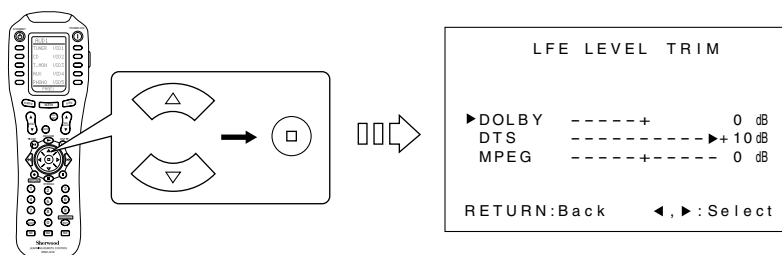

2

Press the CURSOR UP(▲)/DOWN(▼) buttons to select the desired LFE level mode.

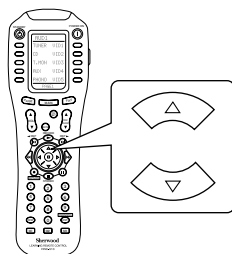

- Each time these buttons are pressed, “▶” is moved to the corresponding LFE level mode.

3

Press the CURSOR LEFT(◀)/RIGHT(▶) buttons to adjust the selected LFE level as desired.

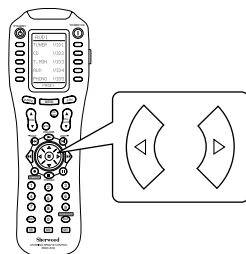

- Each time these buttons are pressed, the LFE level can be adjusted within the range of either -10~0 dB for Dolby Digital program sources or -10~+10 dB for DTS and MPEG program sources.
- In general, we recommend the LFE level for Dolby Digital program sources to be set at 0 dB and at +10 dB for DTS program sources. (However, the recommended LFE level for some early DTS program sources is 0 dB.) If the recommended levels seem too high, lower the setting as necessary.

4

Repeat the above steps ② and ③ until each level is adjusted as desired.

SETTING THE ROOM2 FEED SETUP

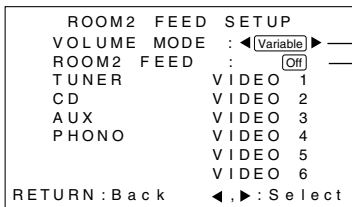

To select the desired volume mode.
To select the desired ROOM 2 source.

- The ROOM 2 function allows enjoying one source in the main room while playing another in a different room at the same time.
- The analog signals from the 8 CH DIRECT inputs and TAPE MONITOR INs cannot be output from the VIDEO 2 / ROOM 2 (audio) OUTs.

When selecting the VOLUME MODE

1

Press the CURSOR UP(▲)/DOWN(▼) buttons to select the VOLUME MODE.

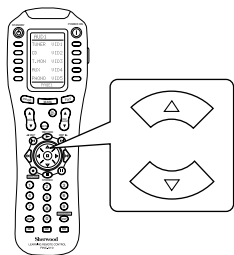

2

Press the CURSOR LEFT(◀)/RIGHT(▶) buttons to select the desired volume mode for the ROOM 2 source.

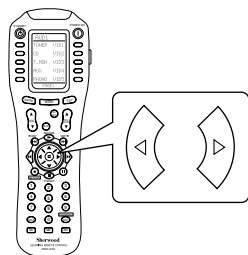

- Each time these buttons are pressed, the volume mode changes as follows:

Variable : Select this when an power amplifier is connected to the VIDEO 2/ROOM 2(audio) OUTs for ROOM 2 source playback. You can adjust the ROOM 2 volume level with the MASTER VOLUME CONTROL knob of this receiver or the VOLUME UP/DOWN buttons on the remote control.



Fixed : Select this when an integrated amplifier, etc. is connected to the VIDEO 2/ROOM 2(audio) OUTs. You can adjust the ROOM 2 volume level on the connected integrated amplifier, etc.

■Notes :

- When you assign the power amplifier for the surround back channels to the ROOM 2, the volume mode is automatically set to Variable.
- In case that an integrated amplifier, etc. is connected to the VIDEO 2/ROOM 2(audio) OUTs and the volume mode is set to Variable, if the ROOM 2 volume level is adjusted to high level on both this receiver and the connected amplifier, the ROOM 2 speaker and the connected amplifier may be damaged. Therefore, be sure to set the volume mode to Fixed for safe operation when using amplifier with its own volume control for ROOM2.
- When selecting the Fixed mode, first adjust the volume level as desired in the Variable mode and select the Fixed mode. Then the volume level will be fixed to the adjusted level.

When selecting the ROOM 2 FEED mode

1

Press the CURSOR UP(▲)/DOWN(▼) buttons to select the ROOM 2 FEED mode.

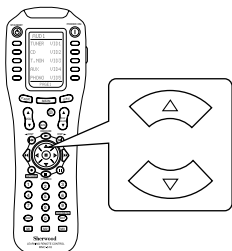

2

Press the CURSOR LEFT(◀)/RIGHT(▶) buttons to select the ROOM 2 FEED mode as desired.

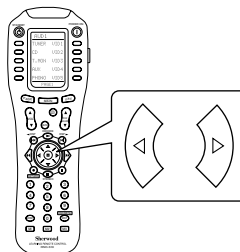

- Each time these buttons are pressed, the ROOM 2 FEED mode is changed to “On” or “Off”.
- When the ROOM 2 FEED mode is set to “Off”, the ROOM 2 source cannot be selected.
- When you do not use the ROOM 2 function, set the ROOM 2 FEED mode to Off to save electricity.

■When the ROOM 2 FEED mode is set to On

3

Press the CURSOR UP(▲)/DOWN(▼)/LEFT(◀)/RIGHT(▶) buttons to select the desired ROOM 2 source, then press the ENTER button.

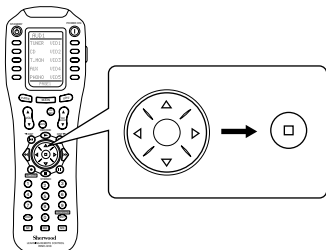

- Each time the CURSOR CONTROL buttons are pressed, “+” is moved to the corresponding input source.
- When the audio and video input sources are both marked with “+”, you can enjoy the sound of the audio input source and the image of the video input source separately.

Troubleshooting Guide

If a fault occurs, run through the table below before taking your unit for repair.

If the fault persists, attempt to solve it by switching the unit off and on again. If this fails to resolve the situation, consult your dealer. Under no circumstances should you repair the unit yourself as this could invalidate the warranty!

PROBLEM	POSSIBLE CAUSE	REMEDY
No power	<ul style="list-style-type: none"> The AC input cord is disconnected. Poor connection at AC wall outlet or the outlet is dead or off. 	<ul style="list-style-type: none"> Connect cord securely. Check the outlet using a lamp or another appliance.
No sound	<ul style="list-style-type: none"> The speaker wires are disconnected. The master volume is adjusted too low. The MUTE button is pressed to ON. The selected decoding mode is not matched to the input signal format. Incorrect selection of input source. Incorrect connections between the components. 	<ul style="list-style-type: none"> Check the speaker connections. Adjust the master volume. Press the MUTE button to cancel the muting effect. Select the available decoding mode. Select the desired input source correctly. Make connections correctly.
No sound from the surround speakers	<ul style="list-style-type: none"> Surround mode is switched off(normal stereo mode). Master volume and surround level are too low. Monaural source is used. Surround speaker setting is "None". 	<ul style="list-style-type: none"> Select a surround mode. Adjust master volume and surround level. Select a stereo or surround source. Select the desired surround speaker setting.
No sound from the center speaker	<ul style="list-style-type: none"> Dolby Virtual Speaker, normal stereo mode, etc is selected. Center speaker setting is "None". Master volume and center level are too low. 	<ul style="list-style-type: none"> Select the desired surround mode. Select the desired center speaker setting. Adjust master volume and center level.
No sound from the surround back speakers	<ul style="list-style-type: none"> The input signal format or the current surround mode cannot support the 7.1(or 6.1) surround. The power amplifier for the surround back channels is assigned to the ROOM 2. Master volume and surround back level are too low. Surround back speaker setting is "None". 	<ul style="list-style-type: none"> Under the proper situations, perform the 7.1(or 6.1) surround playback.(For details, refer to "ENJOYING SURROUND SOUND" on page 30.) Assign the power amplifier to the surround back channels.(For details, refer to "SETTING THE POWER AMP ASSIGN" on page 45.) Adjust master volume and surround back level. Select the desired surround back speaker setting.
Stations cannot be received	<ul style="list-style-type: none"> No antenna is connected. The desired station frequency is not tuned in. Antenna is in wrong position. 	<ul style="list-style-type: none"> Connect an antenna. Tune in the desired station frequency. Move antenna and retry tuning.
Preset stations cannot be received	<ul style="list-style-type: none"> An incorrect station frequency has been memorized. The memorized stations are cleared. 	<ul style="list-style-type: none"> Memorize the correct station frequency. Memorize the stations again.
Poor FM reception	<ul style="list-style-type: none"> No antenna is connected. The antenna is not positioned for the best reception. 	<ul style="list-style-type: none"> Connect an antenna. Change the position of the antenna.
Continuous hissing noise during FM reception, especially when a stereo broadcast is received.	<ul style="list-style-type: none"> Weak signals. 	<ul style="list-style-type: none"> Change the position of the antenna. Install an outdoor FM antenna.
Continuous or intermittent hissing noise during AM reception, especially at night.	<ul style="list-style-type: none"> Noise is caused by motors, fluorescent lamps or lightning, etc. 	<ul style="list-style-type: none"> Keep the receiver away from noise sources. Install an outdoor AM antenna.
Remote control unit does not operate.	<ul style="list-style-type: none"> Batteries are not loaded or exhausted. The remote sensor is obstructed. 	<ul style="list-style-type: none"> Replace the batteries. Remove the obstacle.
Other Sherwood components do not react to remote control commands.	<ul style="list-style-type: none"> DIGI LINK connections are not made properly. 	<ul style="list-style-type: none"> Make proper DIGI LINK connections.
A label cannot be displayed.	<ul style="list-style-type: none"> Malfunction due to external influences such as static electricity, etc. 	<ul style="list-style-type: none"> Clear it using "To clear a label". (Refer to "Correcting or clearing a label" on page 41)
OSD function is not available.	<ul style="list-style-type: none"> Video connections between this unit and the monitor TV are not made correctly. 	<ul style="list-style-type: none"> Make proper video connections.

Specifications

■ AMPLIFIER SECTION

- Power output, stereo mode, 8 Ω, THD 0.05%, 20 Hz~20 kHz | **2 ×120 W**
- Total harmonic distortion, 8 Ω, 120 W, 1 kHz | **0.05 %**
- Intermodulation distortion
60 Hz : 7 kHz = 4 : 1 SMPTE, 8 Ω, 120 W | **0.09 %**
- Input sensitivity/impedance
Phono (MM) | **2.5 mV/47 kΩ**
Line (CD, TAPE MONITOR, VIDEO) | **200 mV/47 kΩ**
- Signal to noise ratio, IHF "A" weighted
Phono (MM) | **80 dB**
Line (CD, TAPE MONITOR, VIDEO) | **105 dB**
- Frequency response
Phono (MM), RIAA, 30~20,000Hz | **±1.0 dB**
LINE (CD, TAPE MONITOR, VIDEO), 10~100,000 Hz | **+0, -3 dB**
- Output level
TAPE MONITOR REC, 1 kΩ | **200 mV**
PRE OUT(Front, Center, Surround, Surround back, Subwoofer), 1 kΩ | **1.0 V**
- Bass/Treble control, 100 Hz/10 kHz | **±10 dB**
- Surround mode, only channel driven
Front power output, 8 Ω, 1 kHz, THD 0.7 % | **140 W+140 W**
Center power output, 8 Ω, 1 kHz, THD 0.7 % | **140 W**
Surround power output, 8 Ω, 1 kHz, THD 0.7 % | **140 W+140 W**
Surround back/ROOM 2 power output, 8 Ω, 1 kHz, THD 0.7 % | **140 W+140 W**

■ DIGITAL AUDIO SECTION

- Sampling frequency | **32, 44.1, 48, 96, 192 kHz**
- Digital input level
Coaxial, 75 Ω | **0.5 Vp-p**
Optical, 660 nm | **-15~-21 dBm**

■ VIDEO SECTION

- Video format | **NTSC**
- Input sensitivity(=Output level), 75 Ω
Video(Composite (normal)) | **1 Vp-p**
S-Video(Luminance signal) | **1 Vp-p**
(chrominance signal) | **0.286 Vp-p**
Component video(R-Y signal) | **0.5 Vp-p**
(B-Y signal) | **0.5 Vp-p**
(Y signal) | **1.0 Vp-p**

■ FM TUNER SECTION

- Tuning frequency range | **87.5~108 MHz**
- Usable sensitivity, THD 3 %, S/N 30 dB | **17.2 dBf**
- 50 dB quieting sensitivity, mono/stereo | **25.2/43.2 dBf**
- Signal to noise ratio, 65 dBf, mono/stereo | **72/68 dB**
- Total harmonic distortion, 65 dBf, 1 kHz, mono/stereo | **0.2/0.3 %**
- Frequency response, 20 Hz~15 kHz | **±1.5 dB**
- Stereo separation, 1 kHz | **45 dB**
- Capture ratio | **3.0 dB**
- IF rejection ratio | **120 dB**

■ AM TUNER SECTION

- Tuning frequency range | **520~1710 kHz**
- Usable sensitivity | **12.5 mV**
- Signal to noise ratio | **51 dB**
- Selectivity | **30 dB**

■ GENERAL

- Power supply | **120 V~60 Hz**
- Power consumption | **7 A**
- Switched AC outlets | **TOTAL 100 W, 1A max.**
- Dimensions(W ×H ×D) | **440 ×196 ×450 mm(17-3/8 ×7-3/4 ×17-3/4 inches)**
- Weight(Net) | **23.5 kg(51.8 lbs)**

Note: Design and specifications are subject to change without notice for improvements.

R-965
Audio/Video Receiver